



AGRICULTURAL
MACHINERY

2015/2016



Supplementary
Agricultural Machinery

2017/2018

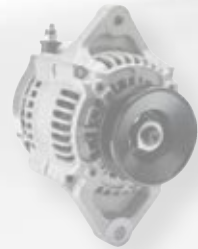

PAGE

ALTERNATORS

<u>Case</u>	6
<u>Caterpillar</u>	6
<u>Claas</u>	7
<u>Deutz-Fahr</u>	7
<u>Fendt</u>	7
<u>Fermec</u>	8
<u>Huerlimann</u>	8
<u>KHD</u>	9
<u>Massey Ferguson</u>	9
<u>New Holland</u>	9
<u>Renault</u>	9
<u>Same</u>	10
<u>Terex</u>	10
<u>Various Agriculture Vehicles</u>	9

STARTERS

<u>Agrifull</u>	12
<u>Case</u>	12
<u>Caterpillar</u>	12
<u>Fendt</u>	13
<u>Goldoni</u>	13
<u>John Deere</u>	14
<u>Same</u>	15
<u>Valtra</u>	15
<u>Various Agriculture Vehicles</u>	15
<u>Yanmar</u>	16

A/C COMPRESSORS

<u>AGCO</u>	18
<u>Caterpillar</u>	18
<u>Claas</u>	18
<u>JCB</u>	18
<u>John Deere</u>	18
<u>Liebherr</u>	19
<u>New Holland</u>	19
<u>Various Agriculture Vehicles</u>	19

PAGE

A/C OILS

<u>Oil</u>	23
Specified Oil	23
Universal Oil	22
<u>Various</u>	22

LIGHTING

<u>Bulbs</u>	39
Conventional	39
H7 Halogen	39
Halogen	40
LED	40
Parking and Flasher - Position	39
Stop and Flasher - Position	39
<u>Forward Lighting</u>	27
Driving Lamp Conventional	27
Driving Lamp LED	27
Tractor Head Lamps	28
<u>Hand Lamps Conventional</u>	26
<u>Hand Lamps LED</u>	26
<u>Pen/Torch Lights</u>	26
Pen-/Torch Lights LED	26
<u>Tail Lights</u>	28
Multi Function Lamps	28
Rear Fog Lamps Conventional	30
Tail Lamps Conventional	30
<u>Warning Lights</u>	30
Flash Lights LED	30
Light Bars LED	33
Rotating Beacons Conventional	33
Rotating Beacons LED	33
<u>Work Lamps LED</u>	34
Work Light Bars LED	38

ELECTRICAL PARTS & ENGINE MANAGEMENT

<u>Cabin Heaters</u>	42
Accessories	45
Connectors	45
<u>Camera & Parking Sensors</u>	46
CCTV Rear Observation System	46
<u>Dashboard Gauges</u>	48

ABBREVIATIONS:

AC=Air Condition, Alu=Aluminium, A=Ampere, AT=Automatic Transmission, Cat.=Catalyzer, Ch.=Chassis, Cyl.=Cylinder, CW=Clockwise rotation, Eur.=European application, FWD.=Front Wheel Drive, H=Height, HD=Heavy Duty construction, HP=Horse Power, ID=Inner Diameter, kW=Kilowatt, L=Length, LHD=Left Hand Drive, LL.=Lead Length, M=Minimum supply, MT=Manual Transmission, m=Metre, OD=Outer Diameter, O.E.=Original Equipment, PS=Power Steering, RHD=Right Hand Drive, Th.=Thickness, V=Volt, W/=With, W/o=Without, W=Watt, 4WD.=Four Wheel Drive, []=Eng. no., 3(2)=Number of fixing holes-number in bracket represent threaded holes.

	PAGE
ELECTRICAL PARTS & ENGINE MANAGEMENT	
Ammeter	48
Voltmeter	48
<u>Fans & Blowers</u>	48
Fan/Heater Motors	48
<u>Power Management Components</u>	49
Battery Isolators	49
Chargers	48
Voltage Converters	49
Voltage Inverters	50
Voltage Reducer	54
<u>Pumps & Pump Parts</u>	54
Electrical Fuel Pumps	54
<u>Switches</u>	54
Battery Switches	54
<u>Wiper Systems</u>	54
Wiper Arms	54
Wiper Blades	54
WORKSHOP CONSUMABLES & TOOLS	
<u>Battery Terminals</u>	56
Quick release terminal	56
<u>Plugs & Sockets</u>	56
Adapters 12 V	56
DIN and Cigarette Lighter	56
ISOBUS	57
Trailer Plugs - 12 V	57
Trailer Sockets - 12 V	57
<u>Relays</u>	57
Multi Plugs	57

	PAGE

Care is taken to ensure the accuracy of descriptions and applications of each item, but assumes no responsibility for possible errors. O.E.M. names and numbers are used for reference purposes only.
 Printed in Denmark. Copyright © 2017 Holger Christiansen A/S, A Bosch Group Company



Alternators

A: Pulley distance, B: Width of holder arm, C: Mounting bracket distance

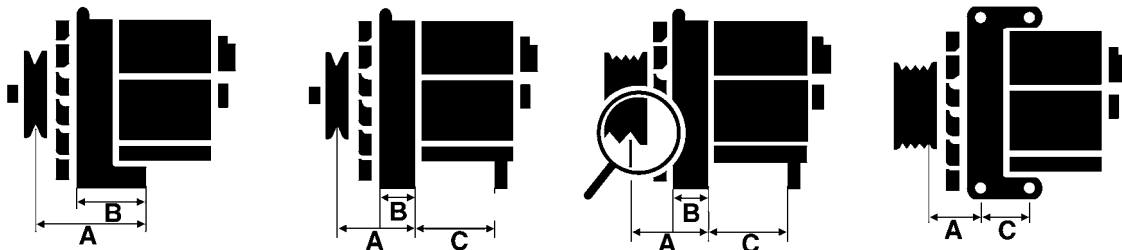

Remarks: Serpentine pulley







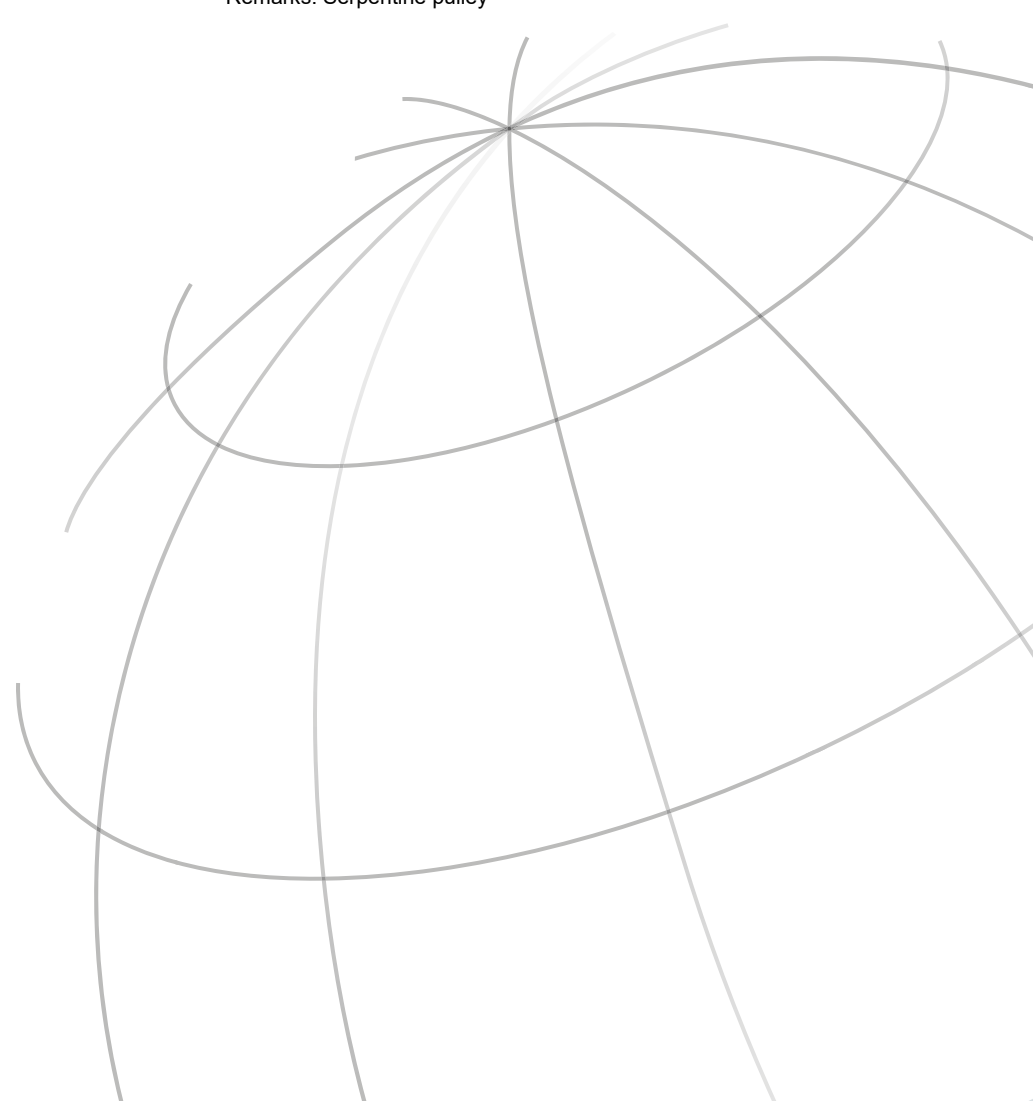







Threaded fixing holes





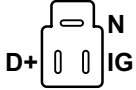

Edition 2017/2018

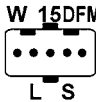

CASE						
	HC-CARGO	Model		Replacing	Information	
 	115680	400 Series	420CT	19020204	Voltage: 14 Ampere: 95 B+: M8 Pulley: SP Grooves: 8 Fan: IF Total length: 193.00 A: 71.50 B: 50.80	
	115682 	Puma	170, 185, 200, 215, 170 CVX, 180 CVX, 185 CVX, 200 CVX, 215 CVX, 225 CVX, 230 CVX	AAN5334, 11.204.175, 11.203.826	Voltage: 14 Ampere: 200 B+: M8 Pulley: SP Grooves: 10 Fan: IF Total length: 205.00 A: 84.00 B: 56.00 Manufacturer: Mahle Letrika	
 	115718	CVX Series	CVX Series	0124525119	Voltage: 14 Ampere: 140 B+: M8 Pulley: SP Grooves: 8 Fan: IF A: 37.50 B: 14.00 C: 80.00	
	116010*	400 Series	434	8600000, 19020208	Voltage: 14 Ampere: 150 Pulley: SP Grooves: 8 Fan: IF	
CATERPILLAR						
	HC-CARGO	Model		Replacing	Information	
 	115724	Various Models	Various Models	101211-3561, 101211-3560	Voltage: 14 Ampere: 45 Pulley: w/o Fan: IF B: 20.00 C: 66.00	
	115812	Various Models	Various Models	19020375, 10459456	Voltage: 14 Ampere: 130 B+: 5/16" UNF Pulley: w/o Fan: EF Total length: 217.00 B: 14.50 C: 100.00	
 	115831*	Various Agriculture Vehicles	311D, 312D, 312D L, 315D L, 319D, 319D L	101211-2780	Voltage: 14 Ampere: 55 Pulley: P Grooves: 1 Fan: IF	
	115995*	Various Models	311D, 312D, 312D L, 315D L, 319D, 319D L, Various Models	A4TU3586, A004TU3586, 34368-02300, 34363-02300	Voltage: 28 Ampere: 50 Pulley: DP Grooves: 2 Fan: EF	

CLAAS					
	HC-CARGO	Model		Replacing	Information
 <p>NEW PRODUCT www.hc-cargo.com</p>	115738	Various Models	Various Models	AAK3156, 11.203.158	Voltage: 14 Ampere: 80 Pulley: P Grooves: 1 Fan: EF
			Atles	Various Models	AC730732, A13VI284, 2542475
DEUTZ-FAHR					
	HC-CARGO	Model		Replacing	Information
	115689	Agrocompact, Antares, Antares II	F100DT, F70DT, F75DT, F90DT, 110, 130, 110DT	AAK3563, AAK3166, 11.203.298, 11.201.463	Voltage: 14 Ampere: 80 B+: M6 Pulley: w/o Fan: EF Total length: 174.00 B: 17.00 C: 66.00
 <p>NEW PRODUCT www.hc-cargo.com</p>	115849	Various Models	Various Models	AAK5832, 11.204.412	Voltage: 28 Ampere: 55 B+: M8 Pulley: P Grooves: 1 Fan: IF Total length: 187.00 A: 33.50 B: 13.80 C: 82.00
			115850*	Antares II, Silver	110DT, Silver
 <p>NEW PRODUCT www.hc-cargo.com</p>	115971*	Various Models	Various Models	AAG5138, AAG5131, 11.204.454, 11.203.970	Voltage: 14 Ampere: 55 B+: M6 Pulley: P Grooves: 1 Fan: IF Total length: 159.00 A: 43.50 B: 19.00 C: 67.00
FENDT					
	HC-CARGO	Model		Replacing	Information
	115987	Farmer, Favorit	300 SERIES, 600, 610, 611, 612, 614, 615, 626 LS	0986043130, 0986041060, 0124615053, 0123510075, 0123510074, 0123510060	Voltage: 14 Ampere: 143 B+: M8 Pulley: w/o Fan: IF Total length: 184.00 Terminal type: L B: 56.00 Bosch Type. Alternative no.: 112196, ca1480ir

FERMEC					
	HC-CARGO	Model		Replacing	Information
	115848	Tractor loaders	860, 865, 960, 965, 640B, 650B	AAK5166, 11.201.881	Voltage: 14 Ampere: 95 B+: M6 Pulley: DP Grooves: 2 Fan: IF Total length: 193.00 A: 36.50 B: 14.00 C: 83.00
HUERLIMANN					
	HC-CARGO	Model		Replacing	Information
	115689	XF-H	100DT, 55DT, 70DT, 75DT, 90DT	AAK3563, AAK3166, 11.203.298, 11.201.463	Voltage: 14 Ampere: 80 B+: M6 Pulley: w/o Fan: EF Total length: 174.00 B: 17.00 C: 66.00
JCB					
	HC-CARGO	Model		Replacing	Information
 	115780	Various Models	Various Models	0-35000-3370	Voltage: 28 Ampere: 40 B+: M5 Terminal: W Pulley: DP Grooves: 2 Fan: EF Total length: 208.00 Terminal type: IG-L A: 59.50 B: 15.65 C: 69.40
	115970*	Various Models	Various Models	AAG5133, AAG5132, AAG5116, 11.204.073, 11.204.067, 11.203.726	Voltage: 14 Ampere: 55 B+: M6 Terminal: W Pulley: P Grooves: 1 Fan: IF Total length: 166.00 A: 43.50 B: 18.00 C: 57.00 Manufacturer: Mahle Letrika
<div style="border: 1px solid black; border-radius: 50%; padding: 10px; display: inline-block;"> NEW PRODUCT www.hc-cargo.com </div>					
JOHN DEERE					
	HC-CARGO	Model		Replacing	Information
  	115780	Various Models	Various Models	0-35000-3370	Voltage: 28 Ampere: 40 B+: M5 Terminal: W Pulley: DP Grooves: 2 Fan: EF Total length: 208.00 Terminal type: IG-L A: 59.50 B: 15.65 C: 69.40
	115812	Various Models	Various Models	19020375, 10459456	Voltage: 14 Ampere: 130 B+: 5/16" UNF Pulley: w/o Fan: EF Total length: 217.00 B: 14.50 C: 100.00

 	115845	Series 7	7290R, 772D, 772G, 770D, 7310R, 770G	0124655013	Voltage: 28 Ampere: 100 B+: M8 Pulley: SP Grooves: 8 Fan: IF Total length: 216.00 A: 44.50 B: 13.50 C: 106.00					
	115849	Harvester	4045	AAK5832, 11.204.412	Voltage: 28 Ampere: 55 B+: M8 Pulley: P Grooves: 1 Fan: IF Total length: 187.00 A: 33.50 B: 13.80 C: 82.00					
KHD										
<table border="1" style="width:100%; border-collapse: collapse;"> <thead> <tr> <th style="width:30%;"></th> <th style="width:10%;">HC-CARGO</th> <th style="width:20%;">Model</th> <th style="width:20%;">Replacing</th> <th style="width:20%;">Information</th> </tr> </thead> </table>							HC-CARGO	Model	Replacing	Information
	HC-CARGO	Model	Replacing	Information						
	115849	Engine	Engine	AAK5832, 11.204.412	Voltage: 28 Ampere: 55 B+: M8 Pulley: P Grooves: 1 Fan: IF Total length: 187.00 A: 33.50 B: 13.80 C: 82.00					
<div style="border: 1px solid #0070C0; border-radius: 50%; padding: 10px; text-align: center; width: fit-content; margin: auto;"> <p style="margin: 0;">NEW PRODUCT</p> <p style="margin: 0;">www.hc-cargo.com</p> </div>	115971*	Various Models	Various Models	AAG5138, AAG5131, 11.204.454, 11.203.970	Voltage: 14 Ampere: 55 B+: M6 Pulley: P Grooves: 1 Fan: IF Total length: 159.00 A: 43.50 B: 19.00 C: 67.00					
MASSEY FERGUSON										
<table border="1" style="width:100%; border-collapse: collapse;"> <thead> <tr> <th style="width:30%;"></th> <th style="width:10%;">HC-CARGO</th> <th style="width:20%;">Model</th> <th style="width:20%;">Replacing</th> <th style="width:20%;">Information</th> </tr> </thead> </table>							HC-CARGO	Model	Replacing	Information
	HC-CARGO	Model	Replacing	Information						
	115777	MF 5000, MF 5400	5425, 5435, 5445, 5450, 5460	AAK4931, 11.203.564	Voltage: 14 Ampere: 80 B+: M8 Terminal: W Pulley: w/o Fan: EF Total length: 173.00 B: 56.00					
NEW HOLLAND										
<table border="1" style="width:100%; border-collapse: collapse;"> <thead> <tr> <th style="width:30%;"></th> <th style="width:10%;">HC-CARGO</th> <th style="width:20%;">Model</th> <th style="width:20%;">Replacing</th> <th style="width:20%;">Information</th> </tr> </thead> </table>							HC-CARGO	Model	Replacing	Information
	HC-CARGO	Model	Replacing	Information						
<div style="border: 1px solid #0070C0; border-radius: 50%; padding: 10px; text-align: center; width: fit-content; margin: auto;"> <p style="margin: 0;">NEW PRODUCT</p> <p style="margin: 0;">www.hc-cargo.com</p> </div>	116010*	Various Models	Various Models	8600000, 19020208	Voltage: 14 Ampere: 150 Pulley: SP Grooves: 8 Fan: IF					
RENAULT										
<table border="1" style="width:100%; border-collapse: collapse;"> <thead> <tr> <th style="width:30%;"></th> <th style="width:10%;">HC-CARGO</th> <th style="width:20%;">Model</th> <th style="width:20%;">Replacing</th> <th style="width:20%;">Information</th> </tr> </thead> </table>							HC-CARGO	Model	Replacing	Information
	HC-CARGO	Model	Replacing	Information						
	115833	Atlas	Various Models	AC730732, A13VI284, 2542475	Voltage: 14 Ampere: 120 B+: M6 Terminal: W Pulley: SP Grooves: 8 Fan: IF Total length: 191.50 A: 31.00 B: 14.00 C: 82.00					

AGRICULTURAL MACHINERY - Alternators

O.E.M. names and numbers are used for reference purposes only.





SAME

	HC-CARGO	Model	Replacing	Information
	115689	Frutteto II 100DT, 70DT, 75DT, 90DT	AAK3563, AAK3166, 11.203.298, 11.201.463	Voltage: 14 Ampere: 80 B+: M6 Pulley: w/o Fan: EF Total length: 174.00 B: 17.00 C: 66.00

TEREX

	HC-CARGO	Model	Replacing	Information
	115848	Backhoe loaders TX750, TX860B, TX860SB, TS960, TS965	AAK5166, 11.201.881	Voltage: 14 Ampere: 95 B+: M6 Pulley: DP Grooves: 2 Fan: IF Total length: 193.00 A: 36.50 B: 14.00 C: 83.00

VARIOUS AGRICULTURE VEHICLES

	HC-CARGO	Model	Replacing	Information
	115605		AAK4835, 11.204.413	Voltage: 14 Ampere: 120 B+: M8 Terminal: W Pulley: SP Grooves: 8 Fan: EF A: 78.00 B: 51.00
 NEW PRODUCT www.hc-cargo.com	115814		0-35000-4858	Voltage: 28 Ampere: 50 Pulley: SP Grooves: 7 Fan: EF
 NEW PRODUCT www.hc-cargo.com	115970*		AAG5133, AAG5132, AAG5116, 11.204.073, 11.204.067, 11.203.726	Voltage: 14 Ampere: 55 B+: M6 Terminal: W Pulley: P Grooves: 1 Fan: IF Total length: 166.00 A: 43.50 B: 18.00 C: 57.00 Manufacturer: Mahle Letrika
 NEW PRODUCT www.hc-cargo.com	116063	Various Agriculture Vehicles	0120689587, 0120689574, 0120689571, 0120689535, 0120689530, 1277670, 11.203.241, 11.203.240, 11.203.139, 11.201.895, 11.201.757, 11.201.519	Voltage: 28 Ampere: 140 B+: M8 Terminal: W Pulley: w/o Fan: EF Total length: 302.00 B: 15.70 C: 182.00 B- M8. Shaft 30 mm. Heavy duty type: HC- CARGO 113589. 180 A. w/o bushing in rear brackethole Alternative no.: 111833



Starters



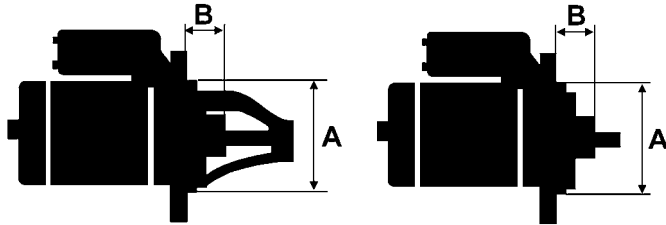











A: Mounting flange, B: Drive distance













Edition 2017/2018





AGRIFULL					
	HC-CARGO	Model		Replacing	Information
	116005*	Various Models	Various Models	AZE4240, 11.132.155	Voltage: 12 kW: 3.2 Gear type: GR Mount. holes: 3 (0)
BOBCAT					
	HC-CARGO	Model		Replacing	Information
 	116071*	Various Models	Various Models	228000-5742, 228000-5741, 228000-5740	Voltage: 12 kW: 1.4 Gear type: GR Mount. holes: 2 (0)
CASE					
	HC-CARGO	Model		Replacing	Information
 	115447*	Various Models	Various Models	8200435	Voltage: 24 kW: 8.0 B+: M12 B-: M12 Total length: 413.00 Gear type: GR Mount. holes: 3 (0) Insulated return A: 92.00 B: 47.50 Replacing: 39mt.
 	115721	CS 660M	CS 660	AZF4598, AZF4553, 11.131.382, 11.131.145	Voltage: 12 kW: 4.2 B+: M10 Total length: 321.50 Gear type: GR Mount. holes: 3 (0) A: 89.00 B: 48.00
	116005*	Various Models	Various Models	AZE4240, 11.132.155	Voltage: 12 kW: 3.2 Gear type: GR Mount. holes: 3 (0)
 	116072*	800 Series, 1000 Series	1150, 850	128000-2563, 128000-2562, 128000-2561, 128000-2560	Voltage: 24 kW: 5.5 Gear type: GR Mount. holes: 3 (0)
CATERPILLAR					
	HC-CARGO	Model		Replacing	Information
 	114718	Various Models	Various Models	428000-3570	Voltage: 12 kW: 1.4 B+: M8 Total length: 188.00 Gear type: GR Mount. holes: 2 (0) A: 74.00 B: 19.00
CUB CADET					
	HC-CARGO	Model		Replacing	Information
 	115972	Various Models	Various Models	428000-2192, 428000-2191, 428000-2190	Voltage: 12 kW: 1.0 B+: M8 Total length: 202.00 Gear type: GR Mount. holes: 2 (0) A: 80.00 B: 20.50













DEUTZ-FAHR					
	HC-CARGO	Model		Replacing	Information
 12 	115355 	Various Models	Various Models	AZF4697, AZF4671, 11.131.870, 11.131.688	Voltage: 24 kW: 5.4 B+: M10 B-: M10 Total length: 355.00 Gear type: GR Mount. holes: 3 (0) Insulated return A: 89.00 B: 48.00 Manufacturer: Mahle Letrika
 9 	116086 	D Series, DX, Intrac, M Series, Various Models	D 6807, D 7007, DX 3.10, DX 3.30, DX 3.50, DX 3.60, DX 3.70, DX 3.80, DX 3.90, DX 4.10, DX 4.30, DX 4.31, DX 4.50, DX 4.70, DX 6.05, DX 6.30, DX 6.31, DX 6.50, DX 6.60, DX 7.10, Intrac 6.30, M 1080, M 1202, M 2385, M 980, M 3360, Various Models	9142802	Voltage: 12 kW: 2.7 Mount. holes: 3 (0) Manufacturer: Magneton Alternative no.: 110536,
FENDT					
	HC-CARGO	Model		Replacing	Information
	116005*	Farmer	102 S, 102	AZE4240, 11.132.155	Voltage: 12 kW: 3.2 Gear type: GR Mount. holes: 3 (0)
 9 	116086 	Farmer, Various Models	204 P, 204 V, 204 PA, 204 VA, 200 Series, 204, Various Models	9142802	Voltage: 12 kW: 2.7 Mount. holes: 3 (0) Manufacturer: Magneton Alternative no.: 110536,
FIAT-ALLIS					
	HC-CARGO	Model		Replacing	Information
 12 	115447*	Various Models	Various Models	8200435	Voltage: 24 kW: 8.0 B+: M12 B-: M12 Total length: 413.00 Gear type: GR Mount. holes: 3 (0) Insulated return A: 92.00 B: 47.50 Replacing: 39mt.
GOLDONI					
	HC-CARGO	Model		Replacing	Information
 9 	116013	Various Models	Various Models	0001354200, 0001314003, 0001109047	Voltage: 12 kW: 1.8 B+: M8 Total length: 255.00 Gear type: GR Mount. holes: 2 (0) A: 82.50 B: 21.00 Alternative no.: 115470

JOHN DEERE



	HC-CARGO	Model		Replacing	Information
 11 	114222*	Various Models	Various Models	TY24443, SE501406, RE70958, RE69705, RE501060, 228000-7413, 228000-7412, 228000-7411, 228000-7410, 228000-6561	Voltage: 24 kW: 7.5 B+: M12 B-: M12 Total length: 319.00 Drive type: Steel Gear type: GR Clutch type: Wet Mount. holes: 3 (0) Oil sealed Waterproof A: 89.00 B: 48.00
 10 	115721	Combines	Various Models	AZF4598, AZF4553, 11.131.382, 11.131.145	Voltage: 12 kW: 4.2 B+: M10 Total length: 321.50 Gear type: GR Mount. holes: 3 (0) A: 89.00 B: 48.00
 11 	115802	Various Models	Various Models	M8T81571, M008T81571, 8980723151, 8980723150	Voltage: 24 kW: 3.2 B+: M8 Total length: 259.00 Gear type: GR Mount. holes: 2 (0) A: 95.00 B: 21.50
 9 	115817	Utility Tractor	Various Models	428000-3130	Voltage: 12 B+: M8 Total length: 205.50 Gear type: DD Mount. holes: 2 (0) A: 62.00 B: 18.00
	115821	Various Models	Various Models	428000-0131, 428000-0130	Voltage: 24 kW: 8.0 B+: 1/2" UNC B-: 1/2" UNC Total length: 447.00 Gear type: GR Mount. holes: 3 (0) Insulated return A: 92.00 B: 46.00
 9 	116016	Tractor Lawn	X495, X595, X740, X744, X748, X749, X750, X754, X758, X950R	428000-0870	Voltage: 12 kW: 1.2 B+: M8 Total length: 183.00 Gear type: GR Mount. holes: 2 (0) A: 95.00 B: 22.00

KHD



	HC-CARGO	Model		Replacing	Information
 12 	115355 	Various Models	Various Models	AZF4697, AZF4671, 11.131.870, 11.131.688	Voltage: 24 kW: 5.4 B+: M10 B-: M10 Total length: 355.00 Gear type: GR Mount. holes: 3 (0) Insulated return A: 89.00 B: 48.00 Manufacturer: Mahle Letrika

LISTER					
	HC-CARGO	Model		Replacing	Information
 12 	115447*	Tractors	Various Models	8200435	Voltage: 24 kW: 8.0 B+: M12 B-: M12 Total length: 413.00 Gear type: GR Mount. holes: 3 (0) Insulated return A: 92.00 B: 47.50 <i>Replacing: 39mt.</i>
 10,11 	115572			27410, 26270	Voltage: 12 kW: 2.1 B+: M8 B-: 1/4" UNC 15a: 6.30 Total length: 307.00 Gear type: DD Mount. holes: 3 (0) A: 92.00 B: 23.50
NEW HOLLAND					
	HC-CARGO	Model		Replacing	Information
 11 	115802	Various Models	Various Models	M8T81571, M008T81571, 8980723151, 8980723150	Voltage: 24 kW: 3.2 B+: M8 Total length: 259.00 Gear type: GR Mount. holes: 2 (0) A: 95.00 B: 21.50
SAME					
	HC-CARGO	Model		Replacing	Information
 11 	116077*	Various Models	Various Models	0001262032	Voltage: 12 kW: 4.2 Mount. holes: 2 (0)
VALTRA					
	HC-CARGO	Model		Replacing	Information
	116070*	600 Series	611	AZF4588, AZF4327, 11.132.189	Voltage: 24 kW: 4.0 Gear type: GR Mount. holes: 3 (0)
VARIOUS AGRICULTURE VEHICLES					
	HC-CARGO	Model		Replacing	Information
 12 	115355 5★	Various Agriculture Vehicles		AZF4697, AZF4671, 11.131.870, 11.131.688	Voltage: 24 kW: 5.4 B+: M10 B-: M10 Total length: 355.00 Gear type: GR Mount. holes: 3 (0) Insulated return A: 89.00 B: 48.00 Manufacturer: Mahle Letrika
 12 	115447*	Various Agriculture Vehicles		8200435	Voltage: 24 kW: 8.0 B+: M12 B-: M12 Total length: 413.00 Gear type: GR Mount. holes: 3 (0) Insulated return A: 92.00 B: 47.50 <i>Replacing: 39mt.</i>





VARIOUS AGRICULTURE VEHICLES

	HC-CARGO	Model		Replacing	Information
 11  <p>NEW PRODUCT www.hc-cargo.com</p>	115954			0-24000-0040, 0-24000-0030	Voltage: 24 kW: 3.0 B+: M10 Total length: 297.00 Gear type: GR Mount. holes: 2 (0) A: 95.00 B: 21.00
 15 	115968	Various Agriculture Vehicles		03101-3180	Voltage: 12 kW: 2.0 B+: M8 Total length: 220.00 Gear type: GR Mount. holes: 2 (0) A: 82.50 B: 26.00
 11  <p>NEW PRODUCT www.hc-cargo.com</p>	116025*	Various Agriculture Vehicles		MS7-301A, M125R3031SE	Voltage: 24 kW: 9.0 Mount. holes: 3 (0) Oil sealed
 12 	116044 			0001330012	Voltage: 24 kW: 6.0 B+: M10 B-: M10 Total length: 367.00 Gear type: GR Mount. holes: 3 (0) Insulated return A: 89.00 B: 48.00 Manufacturer: Bosch Alternative no.: 115464,

VOLVO BM

	HC-CARGO	Model		Replacing	Information
 12 	116044 	Various Tractors	Various Tractors	0001330012	Voltage: 24 kW: 6.0 B+: M10 B-: M10 Total length: 367.00 Gear type: GR Mount. holes: 3 (0) Insulated return A: 89.00 B: 48.00 Manufacturer: Bosch Alternative no.: 115464,

YANMAR

	HC-CARGO	Model		Replacing	Information
 10  <p>NEW PRODUCT www.hc-cargo.com</p>	115991 	Various Models	Various Models	M0T84281, M000T84281	Voltage: 12 kW: 1.2 B+: M8 Total length: 195.00 Gear type: GR Mount. holes: 2 (2) A: 77.00 B: 17.00 Manufacturer: Mitsubishi
 9  <p>NEW PRODUCT www.hc-cargo.com</p>	116016	Cub Cadet SC2400	Cub Cadet SC2400	428000-0870	Voltage: 12 kW: 1.2 B+: M8 Total length: 183.00 Gear type: GR Mount. holes: 2 (0) A: 95.00 B: 22.00



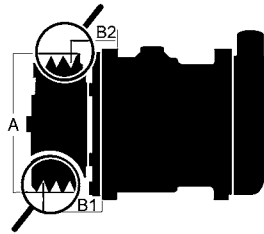
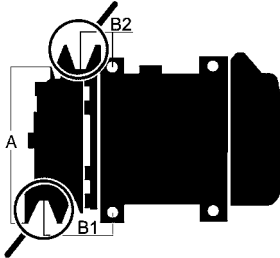

A/C Compressors

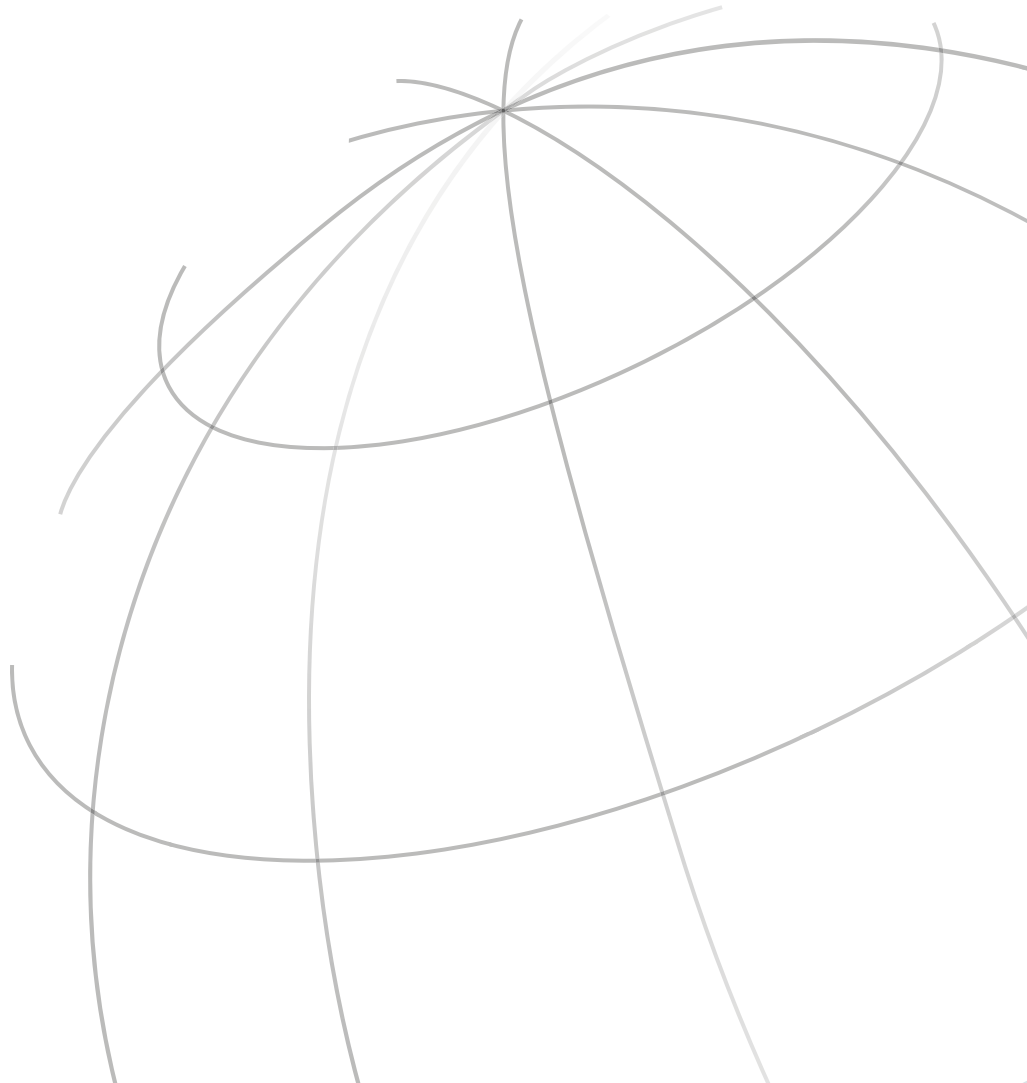

Edition 2017/2018



AGCO				
	HC-CARGO	Model	Replacing	Information
	241589*	Sprayer	1054, 1254, 1844, 6103, 9103, 9105, 8103, 8104, 8144	AG522391
CATERPILLAR				
	HC-CARGO	Model	Replacing	Information
	241583*	Various Models	Various Models	305-0324, 245-7779
CLAAS				
	HC-CARGO	Model	Replacing	Information
	241588*	Jaguar	980	A4572300411, 4572300411
JCB				
	HC-CARGO	Model	Replacing	Information
	241579*	Various Models	Various Models	Voltage: 12 Pulley type: SP Grooves: 8 Family type: SD7H15 Oil type: PAG 46 Oil capacity: 240 ml. Refrigerant: R134a Inlet: 14.90 Inlet position: 50 Outlet: 12.20 Outlet position: 55 A: 120.00 B1: 63.50 B2: 38.50
	241584*	Various Models	Various Models	309-26801
JOHN DEERE				
	HC-CARGO	Model	Replacing	Information
	241166	Various Models	Various Models	447200-4933, 447100-9794

LIEBHERR					
	HC-CARGO	Model		Replacing	Information
<p>NEW PRODUCT www.hc-cargo.com</p> 	241580*	Various Models	Various Models	10116769, 10012488	Voltage: 24 Pulley type: SP Grooves: 8 Family type: SD7H15 Oil type: PAG 46 Oil capacity: 200 ml. Refrigerant: R134a Inlet: 7/8 Inlet position: 55 Outlet: 3/4 Outlet position: 5 A: 119.00 B1: 56.50 B2: 31.50
NEW HOLLAND					
	HC-CARGO	Model		Replacing	Information
<p>NEW PRODUCT www.hc-cargo.com</p>	241582*	Various Models	Various Models	84211904	
VARIOUS AGRICULTURE VEHICLES					
	HC-CARGO	Model		Replacing	Information
<p>NEW PRODUCT www.hc-cargo.com</p>	241293*			AN221429	
<p>NEW PRODUCT www.hc-cargo.com</p> 	241577*			240-101251	Voltage: 24 Pulley type: SP Grooves: 2 Family type: SD7H15 Oil type: PAG 46 Oil capacity: 135 ml. Refrigerant: R134a Inlet: 7/8 Inlet position: 55 Outlet: 3/4 Outlet position: 5 A: 132.00 B1: 39.50 B2: 38.00
<p>NEW PRODUCT www.hc-cargo.com</p>	241578*			X4436025, 4436025	Voltage: 24 Family type: 10S15C



A/C Oils

Edition 2017/2018



UNIVERSAL PARTS
VARIOUS
253517 U/V Leak detection dye Std pkg 1

Content: 237 ml

Refrigerant: R134a

253577 UV Leak detector dye 936 ml Std pkg 1

Content: 936 ml

Refrigerant: R134a

OIL
UNIVERSAL OIL
250345 A/C O-ring Silicone Lube Std pkg 1

A very useful means of: 1) Silicone, neutral towards all materials. 2) High lubricity - Makes it easy to fit and assemble. 3) High viscosity - Sealing the micro-cracks.



Content: 119 ml

253486 Ester Oil + UV Dye Std pkg 1

w/ UV dye.

Content: 237 ml

Refrigerant: R134av

253487 Ester Oil + UV Dye Std pkg 1

w/ UV dye.

Content: 946 ml

Refrigerant: R134a

253520 PAO-oil 68 Std pkg 1

Content: 946 ml

 Refrigerant: R134a
 Viscosity: PAO 68

EL. SPECIFICATIONS	DIMENSIONS	ADDITIONAL SPECIFICATIONS
253521 PAO-oil 68 with UV dye Std pkg 1 w/ UV dye.		Content: 946 ml Refrigerant: R134a Viscosity: PAO 68
253522 PAG 46 Std pkg 1		Content: 946 ml Refrigerant: R134a Viscosity: PAG 46
253523 PAG 100 Std pkg 1		Content: 946 ml Refrigerant: R134a Viscosity: PAG 100
253524 PAG 150 Std pkg 1		Content: 946 ml Refrigerant: R134a Viscosity: PAG 150
253581* PAG 100-YF Oil Std pkg 1 <div style="border: 1px solid #0070C0; border-radius: 50%; padding: 20px; text-align: center; width: fit-content; margin: 20px auto;"> <p>NEW PRODUCT www.hc-cargo.com</p> </div>		Content: 237 ml Refrigerant: 1234YF Viscosity: PAG 100
253583 Hybrid Oil Std pkg 1		Content: 207 ml Refrigerant: R134a
SPECIFIED OIL		
250305 PAG 46 oil Std pkg 1		Content: 237 ml Refrigerant: R134a Viscosity: PAG 46 Alternativ no.: 253483

EL. SPECIFICATIONS		DIMENSIONS	ADDITIONAL SPECIFICATIONS
250306 PAG 100 oil	Std pkg 1		
		Content: 237 ml	Refrigerant: R134a Viscosity: PAG 100 Alternativ no.: 253484
250307 PAG 150 oil	Std pkg 1		
		Content: 237 ml	Refrigerant: R134a Viscosity: PAG 150 Alternativ no.: 253485
253483 PAG 46 Oil + UV dye	Std pkg 1		
w/ UV dye.			
		Content: 237 ml	Refrigerant: R134a Viscosity: PAG 46 Alternativ no.: 250305
253484 PAG 100 Oil + UV dye	Std pkg 1		
w/ UV dye.			
		Content: 237 ml	Refrigerant: R134a Viscosity: PAG 100 Alternativ no.: 250306
253485 PAG 150 Oil + UV dye	Std pkg 1		
w/ UV dye.			
		Content: 237 ml	Refrigerant: R134a Viscosity: PAG 150 Alternativ no.: 250307
253490 PAG 46 Oil + UV dye	Std pkg 1		
w/ UV dye.			
		Content: 946 ml	Refrigerant: R134a Viscosity: PAG 46
253491 PAG 100 Oil + UV dye	Std pkg 1		
w/ UV dye.			
		Content: 946 ml	Refrigerant: R134a Viscosity: PAG 100
253492 PAG 150 Oil + UV dye	Std pkg 1		
w/ UV dye.			
		Content: 946 ml	Refrigerant: R134a Viscosity: PAG 150



Lighting

Edition 2017/2018



PEN/TORCH LIGHTS

PEN-/TORCH LIGHTS LED

172103 LED Penlight - 1 pcs Std pkg 1

Battery: HC-CARGO 200738.



Lumen: 80

Dim.: 200x28x20 mm

 Bulb type: LED
 Battery type: AAA
 Material: Rubber
 No./batteries: 4
 Shoulder strap: w/
 Magnet holder: w/
 Approval: CE
 Alternativ no.: 172104

172104 LED Penlight - 12 pcs Std pkg 1

Battery: HC-CARGO 200738.



Lumen: 80

Dim.: 200x28x20 mm

 Bulb type: LED
 Battery type: AAA
 Material: Rubber
 No./batteries: 4
 Shoulder strap: w/
 Magnet holder: w/
 Approval: CE
 Alternativ no.: 172103

HAND LAMPS CONVENTIONAL

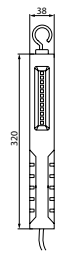
172186 LED Hand Lamp Std pkg 1

Lumen: 400

 Dim.: 32x3.8x2.7 cm
 Length: 320 mm
 Cable length: 5 m
 Weight: 615 g

 Plug: w/
 Tightness norm: IP 20
 Approvals: CE
 Alternativ no.: 200733

HAND LAMPS LED

172187 LED Hand Lamp Std pkg 1

Lumen: 350

Dim.: 28x4.8x4 mm

 Bulb type: LED
 Battery type: Li-ion
 Magnet holder: w/
 Lamp head: Yes
 Rechargeable: Yes
 Approval: CE
 Alternativ no.: 171999

172189 LED Hand Lamp Std pkg 1

 Watt: 3
 Lumen: 300

Dim.: 55x45x215 mm

 Bulb type: LED
 Battery type: Li-ion
 Magnet holder: w/
 Lamp head: Yes
 Wall charger 230 V: Yes
 Charger 12 V: Yes
 Rechargeable: Yes
 Approval: CE

172190 LED Hand Lamp UK Std pkg 1

Lumen: 300

Dim.: 55x45x215 mm

 Bulb type: LED
 Battery type: Li-ion
 Magnet holder: w/
 Lamp head: Yes
 Wall charger 230 V: Yes
 Charger 12 V: Yes
 Rechargeable: Yes
 Approval: CE

FORWARD LIGHTING

DRIVING LAMP CONVENTIONAL

172146 Driving lamp Std pkg 1

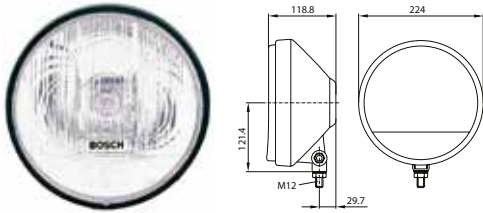

172147 Driving Lamp Std pkg 1

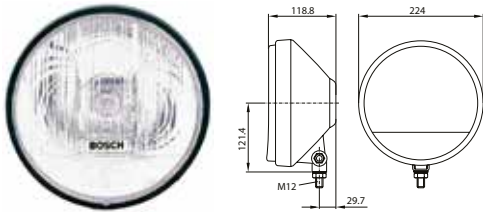

172148 Std pkg 1

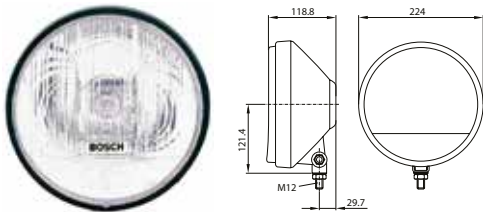

DRIVING LAMP LED

172092 LED Driving Light Bar Std pkg 1

DT Connector: HC-CARGO 193365, 193366.

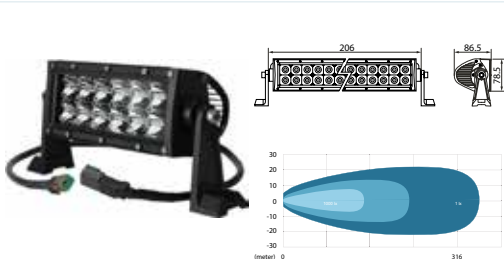

Voltage: 10-30
Amp: 2.2/1.2
Watt: 36
Kelvin: 6000
Lumen: 3240

Dim.:
206x86.5x78.5 mm
Cable length: 500 mm

Type: 12 LED
Colour: Black
Material/dome: Polycarbonate
Material/house: Cast aluminum
Shape: Straight
Mount. bracket: Vertical
Beam shape: Driving
2 poles: Male/female
Tightness norm: IP 69K
Approvals: ECE R112
E-approval: Yes

172093 LED Driving Light Bar Std pkg 1

DT Connector: HC-CARGO 193365, 193366.

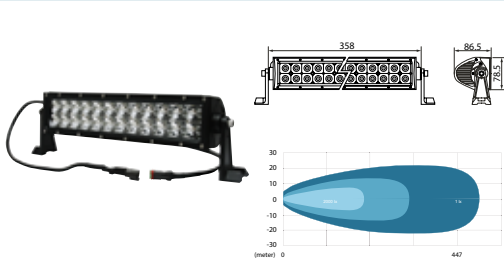

Voltage: 10-30
Amp: 4.2/2.2
Watt: 72
Kelvin: 6000
Lumen: 6480

Dim.:
358x86.5x78.5 mm
Cable length: 500 mm

Type: 24 LED
Colour: Black
Material/dome: Polycarbonate
Material/house: Cast aluminum
Shape: Straight
Mount. bracket: Vertical
Beam shape: Driving
2 poles: Male/female
Tightness norm: IP 69K
Approvals: ECE R112
E-approval: Yes

172102 LED Driving Light Bar Std pkg 1

DT Connector: HC-CARGO 193365, 193366.

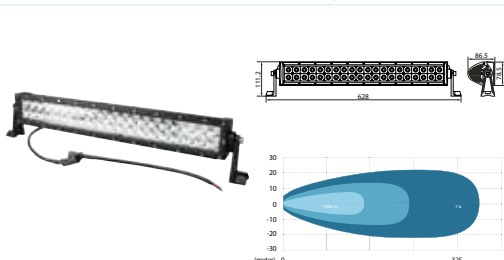

Voltage: 10-30
Amp: 6.6/3.4
Watt: 120
Kelvin: 6000
Lumen: 10800

Dim.:
628x111.2x86.5 mm
Cable length: 500 mm

Type: 40 LED
Colour: Black
Material/dome: Polycarbonate
Material/house: Cast aluminum
Shape: Straight
Mount. bracket: Vertical
Beam shape: Driving
2 poles: Male/female
Tightness norm: IP 69K
Approvals: ECE R112
E-approval: Yes

172144 LED Driving Lamp

Std pkg 1

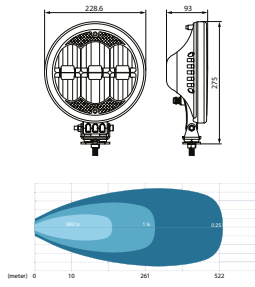

Voltage: 10-30
Watt: 60
Kelvin: 6000
Lumen: 5400

Dim.: 275x228.6x93 mm

Type: LED Driving lamp
Connection: Multiplug
Material: Cast aluminum
Material/dome: Polycarbonate
Shape: Round
No./LEDs: 6
Tightness norm: IP 67
Approvals: ECE R112
E-approval: Yes

TRACTOR HEAD LAMPS

172192 Head Lamp

Std pkg 1

NEW PRODUCT
www.hc-cargo.com

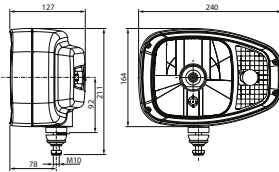

Bulb incl.: w/
Voltage: 12/24
Watt: 60/55
Watt 2: 5
Watt 3: 21

Dim.: 240x164x127 mm

Bulb type: H4
Bulb type 2: W5W
Bulb type 3: PY21W
Socket type: P43t
Socket type 2: T10
Socket type 3: BAU15s
Colour: Black
Material: Shockproof plastic
Material/dome: Glass
Flasher light: w/
Sidemarkers: w/
RH/LH: RH
Approvals: SAE/ECE
E-approval: Yes

172193 Head Lamp

Std pkg 1

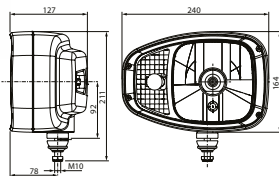

Bulb incl.: w/
Voltage: 12/24
Watt: 60/55
Watt 2: 5
Watt 3: 21

Dim.: 240x164x127 mm

Bulb type: H4
Bulb type 2: W5W
Bulb type 3: PY21W
Socket type: P43t
Socket type 2: T10
Socket type 3: BAU15s
Colour: Black
Material: Shockproof plastic
Material/dome: Glass
Flasher light: w/
Sidemarkers: w/
RH/LH: LH
Approvals: SAE/ECE
E-approval: Yes

172194 LED Head Lamp

Std pkg 1



Lumen: 420

Dim.: 33x45 mm

Battery type: Lithium
Material: Aluminium
No./batteries: 1
Shoulder strap: No
Retractable tripod: No
Rechargeable: Yes
Tightness norm: IP 65

TAIL LIGHTS

MULTI FUNCTION LAMPS

TRAILER LAMPS CONVENTIONAL

172153 Multi Function Lamp

Std pkg 1

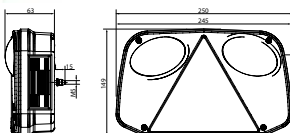

Bulb incl.: Yes
Voltage: 12
Watt: 5

Dim.: 63x149x245 mm
Dist. mount. holes: 152 mm

Socket type: P21
Connection: Multiplug
Colour: Black
Material: Shockproof plastic
Shape: Rectangular
Reflector: w/
Flasher light: w/
Numberplate light: w/
Rear/fog lamp: w/
Sidemarkers: w/
Stop light: w/
RH/LH: LH
E-approval: Yes

		EL. SPECIFICATIONS	DIMENSIONS	ADDITIONAL SPECIFICATIONS
172154 Multi Function Lamp Std pkg 1		Bulb incl.: Yes Voltage: 12 Watt: 5	Dim.: 63x149x245 mm Dist. mount. holes: 152 mm	Socket type: P21 Connection: Multiplug Colour: Black Material/dome: Shockproof plastic Shape: Rectangular Reflector: w/ Flasher light: w/ Numberplate light: w/ Reverse light: w/ Sidemarker: w/ Stop light: w/ RH/LH: RH E-approval: Yes
172155 Multi Function Lamp Std pkg 1		Bulb incl.: Yes Voltage: 12 Watt: 5	Dim.: 62x181x229 mm Dist. mount. holes: 130 mm	Socket type: P21 Colour: Black Colour/glass: Red Shape: Triangle Reflector: w/ Flasher light: w/ Numberplate light: w/ Rear/fog lamp: w/ Sidemarker: w/ Stop light: w/ RH/LH: LH E-approval: Yes
172156 Multi Function Lamp Std pkg 1		Bulb incl.: Yes Voltage: 12 Watt: 5	Dim.: 62x181x229 mm Dist. mount. holes: 130 mm	Socket type: P21 Colour: Black Shape: Triangle Reflector: w/ Flasher light: w/ Numberplate light: w/ Reverse light: w/ Sidemarker: w/ Stop light: w/ RH/LH: RH E-approval: Yes
TRAILER LAMPS LED				
172149 LED Multifunction Lamp Std pkg 1		Voltage: 12/24	Dim.: 163x144 mm Cable length: 1850 mm Dist. mount. holes: 64 mm	Type: LED Tail lamp Connection: Cable Colour: Black Colour/glass: Red Material: PP Material/dome: PMMA Shape: Triangle Mount.: Horizontal Reflector: w/ Fixing screw: 2 Flasher light: w/ Numberplate light: w/ Rear/fog lamp: w/o Reverse light: w/o Sidemarker lamp: w/o Tail light: w/ Stop light: w/ LEDs: w/ RH/LH: LH Tightness norm: IP 66/68 E-approval: Yes
172150 LED Multifunction Lamp Std pkg 1		Voltage: 12-24	Dim.: 163x144 mm Cable length: 1850 mm Dist. mount. holes: 64 mm	Type: LED Tail lamp Connection: Cable Material: PP Material/dome: PMMA Shape: Triangle Mount.: Horizontal Reflector: w/ Fixing screw: 2 Flasher light: w/ Tail light: w/ Stop light: w/ LEDs: w/ RH/LH: LH Tightness norm: IP 66/68 E-approval: Yes

172151 LED Multifunction Lamp Std pkg 1

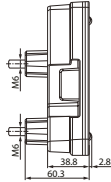
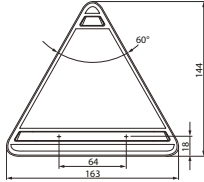

Voltage: 12-24

Dim.: 163x144 mm
Cable length: 1850 mm
Dist. mount. holes: 64 mm

Type: LED Tail lamp
Connection: Cable
Material: PP
Material/dome: PMMA
Shape: Triangle
Mount.: Horizontal
Reflector: w/
Fixing screw: 2
Flasher light: w/
Numberplate light: w/
Rear/fog lamp: w/o
Reverse light: w/o
Sidemarkers lamp: w/o
Tail light: w/
Stop light: w/
LEDs: w/
RH/LH: RH
Tightness norm: IP 66/68
E-approval: Yes

172152 LED Multifunction Lamp Std pkg 1

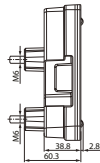
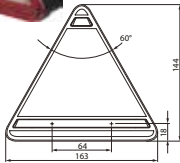

Voltage: 12-24

Dim.: 163x144 mm
Cable length: 1850 mm
Dist. mount. holes: 64 mm

Type: LED Tail lamp
Connection: Cable
Material: PP
Material/dome: PMMA
Shape: Triangle
Mount.: Horizontal
Reflector: w/
Fixing screw: 2
Flasher light: w/
Tail light: w/
Stop light: w/
LEDs: w/
RH/LH: RH
Tightness norm: IP 66/68
E-approval: Yes

REAR FOG LAMPS CONVENTIONAL

172117 Rear Fog Lamp Std pkg 1

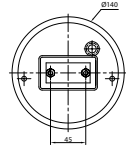
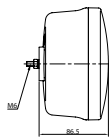

Bulb incl.: No
Watt: 21

Dim.: 140x86.5 mm
Dist. mount. holes: 45 mm

Socket type: BA15S
Connection: Terminal
Colour: Black
Colour/glass: Red
Material: Shockproof plastic
Shape: Round
Fixing screw: 2
Rear/fog lamp: w/
E-approval: Yes

TAIL LAMPS CONVENTIONAL

171174 Position Lamp Std pkg 1

Lens: HC-CARGO 171242.

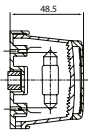
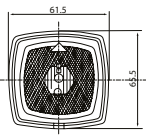

Bulb incl.: No
Watt: 5

Dim.: 62x62x46 mm
Dist. mount. holes: 30 mm

Socket type: S8.5
Connection: Terminal
Colour: Black
Colour/glass: White
Material: Shockproof plastic
Shape: Square
Reflector: w/
Fixing screw: 2
E-approval: Yes

WARNING LIGHTS

FLASH LIGHTS LED

172087 LED Flash, amber Std pkg 1



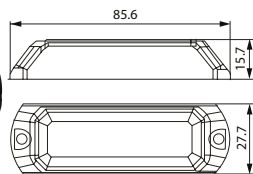

Rubber Adapter for Flush Mount: HC-CARGO 171816.



Voltage: 12-24

Length: 85.6 mm
Height: 15.7 mm
Width: 27.7 mm

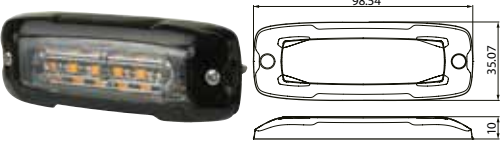
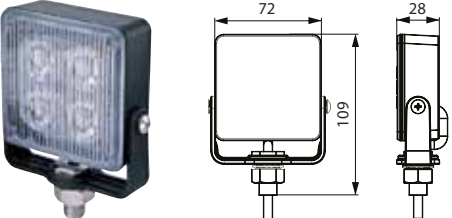
Bulb type: 3 LED
Lens type: Polycarbonate
Colour: Orange
Material: Aluminium
Flash patterns: 12
Waterproof: Yes
Approvals: SAE/ECE-R65
E-approval: Yes
Alternativ no.: 171815

172089 LED Safety Flash Std pkg 1 <i>w/ hook. Battery: 3x HC-CARGO 200738.</i>			
		OD: 105 mm Height: 35 mm	Bulb type: 12 LED Colour: Orange Mount.: 1 magnet Flash patterns: 9 Tightness norm: IP 67 Approvals: CE/EMC
172090 LED Safety Flash Std pkg 1 <i>Rechargeable.</i>			
	Voltage: 12/24 Amp: 1.5	OD: 120 mm Height: 35 mm Temp.: -40 - +60 °C	Bulb type: 16 LED Colour: Orange Mount.: 1 magnet Flash patterns: 9 Wall charger 230 V: Yes Charger 12 V: Yes Tightness norm: IP 67 Approvals: CE/EMC
172091 LED Safety Flash Std pkg 1 <i>Rechargeable. Suitcase w/ 6 pcs.</i>			
	Voltage: 12/24 Amp: 1.5	OD: 120 mm Height: 35 mm Temp.: -40 - +60 °C	Bulb type: 16 LED Colour: Orange Mount.: 1 magnet Flash patterns: 9 Wall charger 230 V: Yes Charger 12 V: Yes Tightness norm: IP 67 Approvals: CE/EMC
172112 LED Flash, amber Std pkg 1			
	Voltage: 12-24 Amp: 0.88/0.44 Watt: 10.5	Length: 98.54 mm Cable length: 250 mm Height: 35.07 mm Width: 10 mm	Bulb type: 6 LED Lens type: Polycarbonate Colour: Orange Material: Aluminium Mount.: Plan Flash patterns: 16 Waterproof: Yes Approvals: EMC/ECE-R65 E-approval: Yes
172113 LED Flash, amber Std pkg 1			
	Voltage: 12/24 Amp: 0.27-0.13 Watt: 3.5	Length: 109 mm Cable length: 1200 mm Height: 28 mm Width: 72 mm	Bulb type: LED Lens type: Polycarbonate Colour: Orange Material: Aluminium Flash patterns: 19 Coiled cable incl.: No Waterproof: Yes Approvals: SAE/ECE-R65
172118 LED Safety Flash UK Std pkg 1 <i>UK version. Rechargeable. Suitcase w/ 6 pcs.</i>			
	Voltage: 12/24 Amp: 1.5	OD: 120 mm Height: 35 mm Temp.: -40 - +60 °C	Bulb type: 16 LED Colour: Orange Mount.: 1 magnet Flash patterns: 9 Wall charger 230 V: Yes Charger 12 V: Yes Tightness norm: IP 67 Approvals: CE/EMC
172121 LED Safety Flash UK Std pkg 1 <i>UK version. Rechargeable.</i>			
	Voltage: 12/24 Amp: 1.5	OD: 120 mm Height: 35 mm Temp.: -40 - +60 °C	Bulb type: 16 LED Colour: Orange Mount.: 1 magnet Flash patterns: 9 Wall charger 230 V: Yes Charger 12 V: Yes Tightness norm: IP 67 Approvals: CE/EMC

EL. SPECIFICATIONS

DIMENSIONS

ADDITIONAL SPECIFICATIONS

172122 LED Flash, amber

Std pkg 1

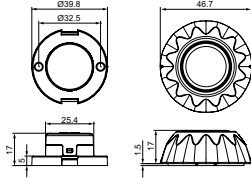

Voltage: 12/24
Amp: 0.24/0.12
Watt: 2.82

Cable length: 200 mm
Height: 17 mm
Dist. mount. holes: 32.5 mm
Width: 46.7 mm

Bulb type: 3 LED
Colour: Orange
Mount.: Plan
Flash patterns: 12
Tightness norm: IP 67
Approvals: SAE/CE

172124 LED Flash, amber

Std pkg 1

Mounting Bracket: HC-CARGO 172125.

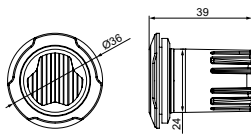

Voltage: 12/24
Amp: 0.24/0.12
Watt: 2.85

Cable length: 200 mm
Height: 39 mm
Width: 36 mm

Bulb type: 3 LED
Colour: Orange
Mount.: Built-in
Flash patterns: 16
Tightness norm: IP 67
Approvals: SAE/ECE-R65
E-approval: Yes

172137 LED Flash, amber

Std pkg 1

Multi-module synchronization.

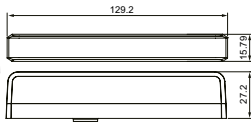

Voltage: 12-24
Amp: 1.14/0.57
Watt: 13

Length: 129.2 mm
Height: 15.79 mm
Width: 27.2 mm

Bulb type: 6 LED
Colour: Orange
Material: Aluminium
Flash patterns: 23
Approvals: SAE/ECE
E-approval: Yes

172139 LED Flash, amber

Std pkg 1

Multi-module synchronization.

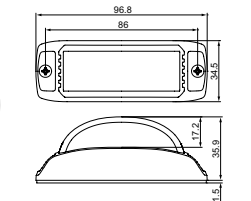

Voltage: 12-24
Amp: 1.14/0.57
Watt: 13

Length: 96.8 mm
Height: 34.5 mm
Width: 35.9 mm

Bulb type: 6 LED
Colour: Orange
Material: Aluminium
Flash patterns: 16
Approvals: SAE/ECE
E-approval: Yes

172140 LED Flash, blue

Std pkg 1

Multi-module synchronization.

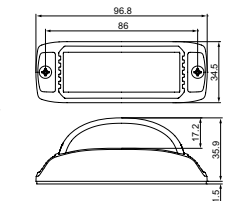

Voltage: 12-24
Amp: 1.14/0.57
Watt: 13

Length: 96.8 mm
Height: 34.5 mm
Width: 35.9 mm

Bulb type: 6 LED
Colour: Blue
Material: Aluminium
Flash patterns: 16
Approvals: SAE/ECE
E-approval: Yes

172142 LED Flash, amber

Std pkg 1

Multi-module synchronization.

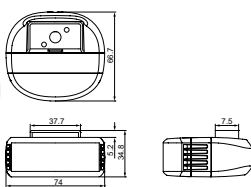

Voltage: 12-24
Amp: 1.14/0.57
Watt: 13

Length: 66.7 mm
Height: 34.8 mm
Width: 7.5 mm

Bulb type: 6 LED
Colour: Orange
Material: Aluminium
Flash patterns: 16
Approvals: SAE/ECE
E-approval: Yes

ACCESSORIES

172125 Mounting Bracket

Std pkg 1

Servicing: HC-CARGO 172123, 172124



LIGHT BARS LED

172094 LED Mini Light Bar Std pkg 1

Switch Panel: HC-CARGO 171762.

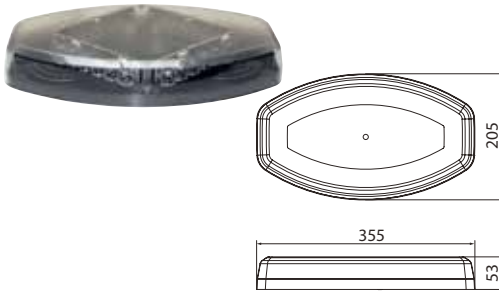

Voltage: 12/24
Amp: 2.88/1.44
Watt: 34.5

Length: 355 mm
Cable length: 3000 mm
Height: 53 mm
Dist. mount. holes: 204 mm
Width: 205 mm

Bulb type: 24 LED
Lens type: Polycarbonate
Colour: Orange
Material: Shockproof plastic
Mount.: Screw
Flash patterns: 23
Waterproof: Yes
Tightness norm: IP 64K
Approvals: EMC-R10/ECE-R65
E-approval: Yes

172115 LED Mini Light Bar Std pkg 1

Switch Panel: HC-CARGO 171762.

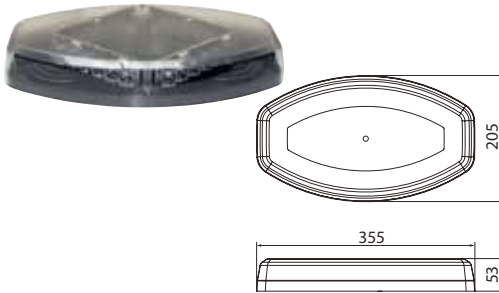

Voltage: 12/24
Amp: 2.88/1.44
Watt: 34.5

Length: 355 mm
Cable length: 3000 mm
Height: 53 mm
Dist. mount. holes: 204 mm
Width: 205 mm

Bulb type: 24 LED
Lens type: Polycarbonate
Colour: Blue
Material: Shockproof plastic
Mount.: Screw
Flash patterns: 23
Waterproof: Yes
Tightness norm: IP 64K
Approvals: ECE-R10/ECE-R65
E-approval: Yes

ROTATING BEACONS CONVENTIONAL

SPARE PARTS

172110 Dome Std pkg 1 Servicing: HC-CARGO 172099, 172100, 172101



OD: 140 mm

Lens type: PMMA/ACRYL
Colour: Orange
E-approval: Yes

ROTATING BEACONS LED

172099 LED Beacon Std pkg 1

Dome: HC-CARGO 172110.

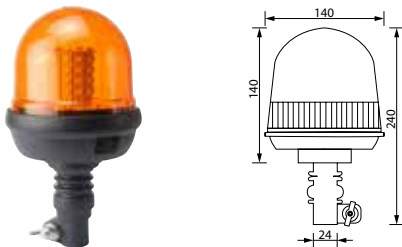

Voltage: 10-30
Watt: 9

OD: 140 mm
Height: 240 mm

Bulb type: 40 LED
Lens type: Polycarbonate
Colour: Orange
Material: Plastic/nylon/rubber
Mount.: Standard ISO A - Rod
Base: Flexible
Flash patterns: 3
Tightness norm: IP 65
Approvals: ECE-R65
E-approval: Yes

172100 LED Beacon Std pkg 1

Dome: HC-CARGO 172110.

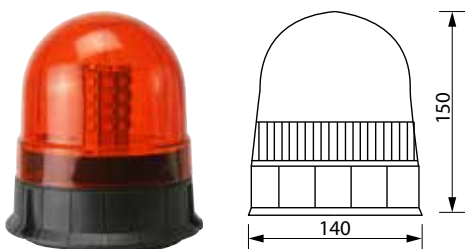

Voltage: 10-30
Watt: 9

OD: 140 mm
Height: 150 mm
Dist. mount. holes: 107 mm

Bulb type: 40 LED
Lens type: Polycarbonate
Colour: Orange
Material: Plastic/nylon/rubber
Mount.: Plan
Flash patterns: 3
Tightness norm: IP 65
Approvals: ECE-R65
E-approval: Yes

172101 LED Beacon Std pkg 1

Max. 120 kph. Dome: HC-CARGO 172110.

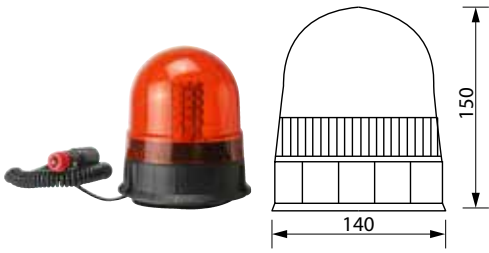

Voltage: 10-30
Watt: 9

OD: 140 mm
Height: 150 mm
Dist. mount. holes: 107 mm

Bulb type: 40 LED
Lens type: Polycarbonate
Colour: Orange
Material: Plastic/nylon/rubber
Mount.: Plan
Base: Magnetic/vacuum
Flash patterns: 3
Coiled cable incl.: Yes
Tightness norm: IP 65
Approvals: ECE-R65
E-approval: Yes

172114 LED Beacon Std pkg 1

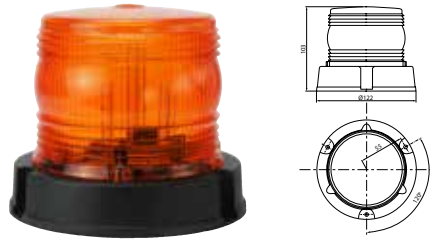
Dome: HC-CARGO 171590.

Voltage: 10-100
Amp: 0.3
Watt: 5.5

OD: 122 mm
Height: 103 mm
Temp.: -20 - +55 °C

Bulb type: 9 LED
Lens type: PMMA
Colour: Orange
Mount.: Standard ISO B2 (and B1) - Base
Flash patterns: 1
Approvals: CE/EMC

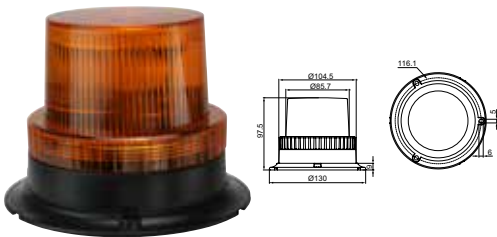
172145 LED Beacon Std pkg 1

Voltage: 11-110
Amp: 0.4
Watt: 3

OD: 130 mm
Cable length: 400 mm
Height: 97.5 mm

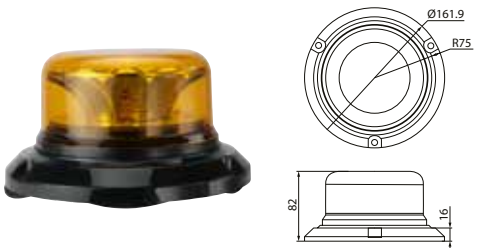
Bulb type: 3 LED
Lens type: Polycarbonate
Colour: Orange
Mount.: Plan
Flash patterns: 5
Hi impact: Yes
Coiled cable incl.: No
Approvals: SAE/ECE
E-approval: No
Alternativ no.: 171674

172183 LED Beacon Std pkg 1

Voltage: 12-36

OD: 161.9 mm
Cable length: 340 mm
Height: 82 mm
Temp.: -30 - +50 °C

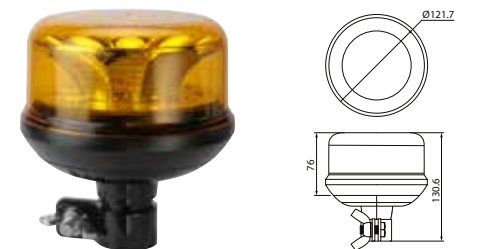
Bulb type: 12 LED
Lens type: Polycarbonate
Colour: Orange
Material: Aluminium
Mount.: Plan
Flash patterns: 5
Hi impact: Yes
Waterproof: Yes
Tightness norm: IP 69K
Approvals: EMC-R10/ECE-R65
E-approval: Yes

172184 LED Beacon Std pkg 1

Voltage: 12-36



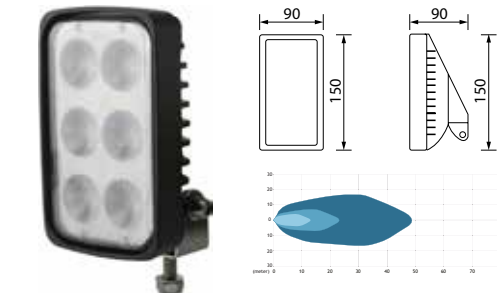





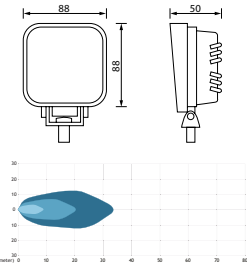

OD: 121.7 mm
Height: 130.6 mm
Temp.: -30 - +50 °C

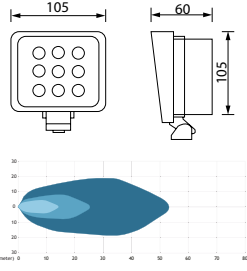
Bulb type: 12 LED
Lens type: Polycarbonate
Colour: Orange
Material: Aluminium
Mount.: Standard ISO A - Rod
Flash patterns: 2
Hi impact: Yes
Waterproof: Yes
Tightness norm: IP 69K
Approvals: EMC-R10/ECE-R65
E-approval: Yes

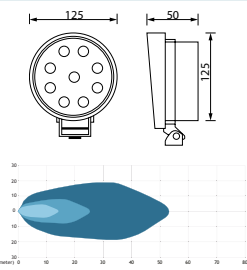
WORK LAMPS LED
172088 LED Work Lamp Std pkg 1

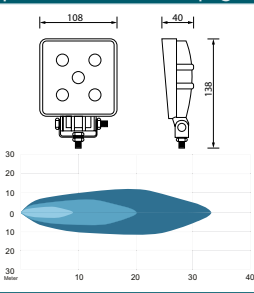
Voltage: 10-30
Watt: 30
Kelvin: 6000
Lumen: 2400

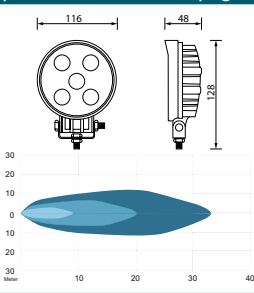
Dim.: 150x90x90 mm
Cable length: 350 mm

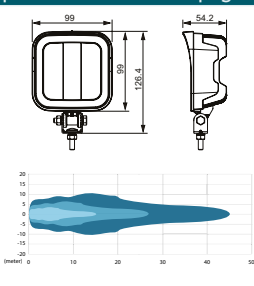
Type: 6 LED
Material/dome: Polycarbonate
Material/house: Aluminium
Shape: Rectangular
Mount.: Sidemounted
Switch: w/o
Beam shape: Flood
2 poles: w/
Tightness norm: IP 69K
Approvals: CE/EMC

		EL. SPECIFICATIONS	DIMENSIONS	ADDITIONAL SPECIFICATIONS
172105 LED Work Lamp		Std pkg 1		
		Voltage: 10-30 Watt: 15 Kelvin: 6000 Lumen: 1200	Dim.: 88x88x50 mm Cable length: 450 mm	Type: 5 LED Colour: Black Material/dome: Polycarbonate Material/house: Aluminium Switch: w/o Beam shape: Flood 2 poles: Male/female Tightness norm: IP 69K Approvals: CE/EMC
172106 LED Work Lamp		Std pkg 1		
		Voltage: 10-30 Watt: 27 Kelvin: 6000 Lumen: 2160	Dim.: 105x105x60 mm Cable length: 450 mm	Type: 9 LED Colour: Black Material/dome: Polycarbonate Material/house: Aluminium Switch: w/o Beam shape: Flood 2 poles: Male/female Tightness norm: IP 69K Approvals: CE/EMC
172107 LED Work Lamp		Std pkg 1		
		Voltage: 10-30 Watt: 27 Kelvin: 6000 Lumen: 2160	Dim.: 125x125x50 mm Cable length: 450 mm	Type: 9 LED Colour: Black Material/dome: Polycarbonate Material/house: Aluminium Switch: w/o Beam shape: Flood 2 poles: Male/female Tightness norm: IP 69K Approvals: CE/EMC
172119 LED Work Lamp		Std pkg 1		
		Voltage: 10-30 Watt: 15 Kelvin: 6000 Lumen: 1100	Dim.: 138x108x40 mm Cable length: 265 mm	Type: 5 LED Colour: Black Material/ bracket: Stainless steel Material/dome: Polycarbonate Material/house: Cast aluminum Shape: Square Switch: w/o Beam shape: Flood Tightness norm: IP 67 Approvals: CE/EMC Alternativ no.: 171948
172120 LED Work Lamp		Std pkg 1		
		Voltage: 10-30 Watt: 15 Kelvin: 6000 Lumen: 1100	Dim.: 128x116x48 mm Cable length: 265 mm	Type: 5 LED Colour: Black Material/ bracket: Stainless steel Material/dome: Polycarbonate Material/house: Cast aluminum Shape: Round Switch: w/o Beam shape: Flood Tightness norm: IP 67 Approvals: CE/EMC Alternativ no.: 171950
172126 LED Work Lamp		Std pkg 1		
		Voltage: 12-36 Watt: 19.3 Lumen: 2160	Dim.: 126.4x99x54.2 mm Cable length: 300 mm	Type: 9 LED Colour: Black Material/dome: Polycarbonate Material/house: Aluminium Shape: Square Beam shape: Flood Tightness norm: IP 69K Approvals: CE/EMC Alternativ no.: 171751

172127 LED Work Lamp		Std pkg 1		EL. SPECIFICATIONS	DIMENSIONS	ADDITIONAL SPECIFICATIONS
		Voltage: 12-36 Watt: 8.4 Candela: 1200 Lumen: 720	Dim.: 131.3x70x42.6 mm Cable length: 300 mm	Type: 3 LED Colour: Black Material/ bracket: Stainless steel Material/dome: Polycarbonate Material/house: Shock thermo plastic Shape: Square Beam shape: Flood 2 poles: w/ Tightness norm: IP 67 Approvals: CE/EMC		
		Voltage: 12-36 Watt: 22 Lumen: 2160	Dim.: 188.4x125x82 mm Cable length: 280 mm	Type: 9 LED Colour: Red/black Material/ bracket: Stainless steel Material/dome: Polycarbonate Material/house: Aluminium Shape: Square Switch: w/ Handle: w/ Beam shape: Flood 2 poles: w/ Tightness norm: IP 69K Approvals: CE/EMC		
		Voltage: 12-36 Watt: 40 Lumen: 4800	Dim.: 136.1x110x65.9 mm Cable length: 350 mm	Type: 6 LED Colour: Black Material/ bracket: Stainless steel Material/dome: Polycarbonate Material/house: Aluminium Shape: Square Beam shape: Flood 2 poles: w/ Tightness norm: IP 69K Approvals: CE/EMC Alternativ no.: 171752, 172010		
		Voltage: 12-36 Watt: 22 Lumen: 1490	Dim.: 75.6x70x57 mm Cable length: 2000 mm	Type: 9 LED Colour: Red/black Material/dome: Polycarbonate Material/house: Aluminium Shape: Square Magnet base: w/ Beam shape: Flood Coiled cable incl.: Yes Tightness norm: IP 69K Approvals: CE/EMC		
		Voltage: 10-60 Watt: 30 Kelvin: 6000 Lumen: 2400	Dim.: 119x105x80 mm Cable length: 460 mm	Type: 6 LED Colour: Black Material/ bracket: Stainless steel Material/dome: Polycarbonate Material/house: Aluminium Shape: Square Beam shape: Spot Tightness norm: IP 68/69K Approvals: CE/EMC		
		Voltage: 10-60 Watt: 35 Kelvin: 6000 Lumen: 2800	Dim.: 119x105x80 mm Cable length: 460 mm	Type: 1 LED Colour: Black Material/ bracket: Stainless steel Material/dome: Polycarbonate Material/house: Aluminium Shape: Square Beam shape: Flood Tightness norm: IP 68/69K Approvals: CE/EMC		

EL. SPECIFICATIONS		DIMENSIONS	ADDITIONAL SPECIFICATIONS
172133 LED Work Lamp Std pkg 1 		Voltage: 10-30 Watt: 15 Kelvin: 6000 Lumen: 1200	Dim.: 130x78x53 mm Cable length: 460 mm Type: 5 LED Colour: Black Material/ bracket: Stainless steel Material/dome: Polycarbonate Material/house: Aluminium Shape: Oval Beam shape: Flood Tightness norm: IP 68/69K Approvals: CE/EMC
172134 LED Work Lamp Std pkg 1 		Voltage: 10-30 Watt: 24 Kelvin: 6000 Lumen: 1920	Dim.: 130x78x53 mm Cable length: 460 mm Type: 8 LED Colour: Black Material/ bracket: Stainless steel Material/dome: Polycarbonate Material/house: Aluminium Shape: Oval Beam shape: Flood Tightness norm: IP 68/69K Approvals: CE/EMC
172135 LED Work Lamp Std pkg 1 		Voltage: 10-60 Watt: 20 Kelvin: 6000 Lumen: 1600	Dim.: 150x40x65 mm Cable length: 460 mm Type: 4 LED Colour: Black Material/ bracket: Stainless steel Material/dome: Polycarbonate Material/house: Aluminium Shape: Oblong Beam shape: Flood 2 poles: w/ Tightness norm: IP 68/69K Approvals: CE/EMC
172136 LED Work Lamp Std pkg 1 		Voltage: 10-60 Watt: 30 Kelvin: 6000 Lumen: 2400	Dim.: 215x40x65 mm Cable length: 460 mm Type: 6 LED Colour: Black Material/ bracket: Stainless steel Material/dome: Polycarbonate Material/house: Aluminium Shape: Oblong Beam shape: Flood 2 poles: w/ Tightness norm: IP 68/69K Approvals: CE/EMC
172143 LED Work Lamp Std pkg 1 		Voltage: 10-30 Watt: 15 Kelvin: 6000 Lumen: 1426	Dim.: 150x80x38 mm Type: 10 LED Colour: Black Material/ bracket: Stainless steel Material/dome: Polycarbonate Material/house: Cast aluminum Shape: Rectangular Beam shape: Flood Tightness norm: IP 67/IP 69K Approvals: CE/EMC
172191 LED Work Lamp Std pkg 1 Servicing: John Deere 		Voltage: 10-30 Watt: 40 Kelvin: 6000 Lumen: 3200	Dim.: 170x105x80 mm Type: 8 LED Colour: Black Material/dome: Polycarbonate Material/house: Cast aluminum Shape: Oval Beam shape: Flood Tightness norm: IP 68/69K Approvals: CE/ECE

WORK LIGHT BARS LED

172095 LED Work light bar Std pkg 1

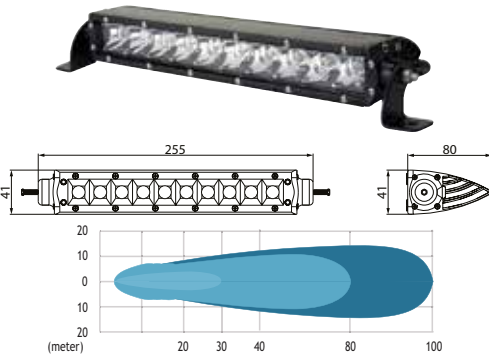

Voltage: 10-30
Amp: 3.2/1.6
Watt: 50
Kelvin: 6000
Lumen: 4000

Dim.: 255x80x41 mm
Cable length: 220 mm

Type: 10 LED
Inclination/downwards: 90°
Inclination/upwards: 15°
Colour: Black
Material/ bracket: Stainless steel
Material/dome: Polycarbonate
Material/house: Aluminium
Reflector system: Spot
Shape: Straight
Mount.: Upright/pendant
Mount. bracket: Sidemounted
Beam shape: Spot
2 poles: Male/female
Tightness norm: IP 67
Approvals: CE/EMC
E-approval: No

172096 LED Work light bar Std pkg 1

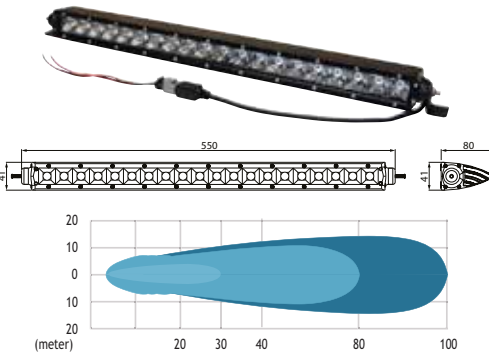

Voltage: 10-30
Amp: 6.25/3.125
Watt: 100
Kelvin: 6000
Lumen: 8000

Dim.: 550x80x41 mm
Cable length: 220 mm

Type: 20 LED
Inclination/downwards: 90°
Inclination/upwards: 15°
Colour: Black
Material/ bracket: Stainless steel
Material/dome: Polycarbonate
Material/house: Aluminium
Reflector system: Spot
Shape: Straight
Mount.: Upright/pendant
Mount. bracket: Sidemounted
Beam shape: Spot
2 poles: Male/female
Tightness norm: IP 67
Approvals: CE/EMC
E-approval: No

172097 LED Work light bar Std pkg 1

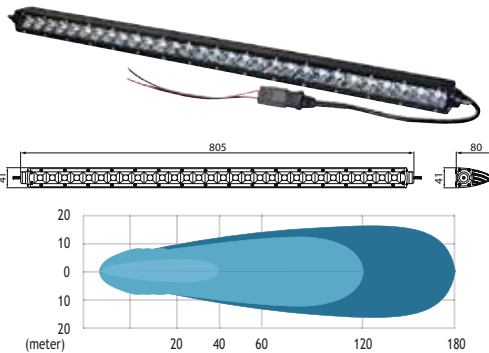

Voltage: 10-30
Amp: 9.45/4.7
Watt: 150
Kelvin: 6000
Lumen: 12000

Dim.: 805x80x41 mm
Cable length: 3000 mm

Type: 30 LED
Inclination/downwards: 90°
Inclination/upwards: 15°
Colour: Black
Material/ bracket: Stainless steel
Material/dome: Polycarbonate
Material/house: Aluminium
Reflector system: Spot
Shape: Straight
Mount.: Upright/pendant
Mount. bracket: Sidemounted
Beam shape: Spot
2 poles: Male/female
Tightness norm: IP 67
Approvals: CE/EMC
E-approval: No

172098 LED Work light bar Std pkg 1

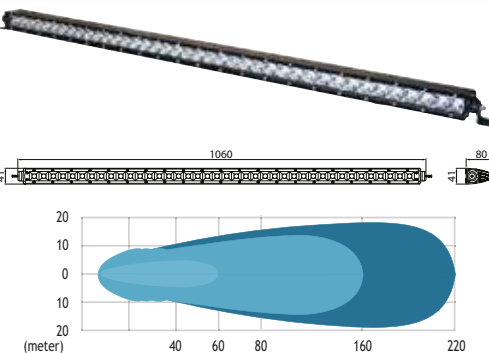

Voltage: 10-30
Amp: 12.5/6.25
Watt: 200
Kelvin: 6000
Lumen: 16000

Dim.: 1060x80x41 mm
Cable length: 3000 mm

Type: 40 LED
Inclination/downwards: 90°
Inclination/upwards: 15°
Colour: Black
Material/ bracket: Stainless steel
Material/dome: Polycarbonate
Material/house: Aluminium
Reflector system: Spot
Shape: Straight
Mount.: Upright/pendant
Mount. bracket: Sidemounted
Beam shape: Spot
2 poles: Male/female
Tightness norm: IP 67
Approvals: CE/EMC
E-approval: No

SPARE PARTS

172116 Mounting Bracket Kit Std pkg 1 Servicing: HC-CARGO 172077, 172078, 172079, 172080



BULBS

H7 Halogen

	HC-CARGO	Std. pkg.	Voltage	Watt	Length	OD	Colour	Type	Comment
	172111	Pkg. 1	24	100	58 mm	34 mm		H7, Heavy duty	Not E-approved

Stop and Flasher - Position

	HC-CARGO	Std. pkg.	Voltage	Watt	Length	OD	Colour	Type	Comment
 BA15d	171998	Pkg. 10	6	15	45 mm	26.5 mm			
	171989	Pkg. 10	12	20	45 mm	26.5 mm			
	171994	Pkg. 10	12	205	52.2 mm	22.5 mm			
	171982	Pkg. 10	24	20	45 mm	26.5 mm		Heavy duty	
 BA15S	171995	Pkg. 10	6	20	45 mm	26.5 mm			
	171984	Pkg. 10	6	21	52.5 mm	26.5 mm			
	171992	Pkg. 10	12	10	35 mm	19 mm		Longlife	
	171990	Pkg. 10	12	15	35 mm	19 mm			
	171988	Pkg. 10	12	18	45 mm	26.5 mm			
	171979	Pkg. 10	12	21	52.5 mm	26.5 mm		P21W, Longlife	
	171997	Pkg. 10	24	15	35 mm	19 mm		Heavy duty	
	171996	Pkg. 10	24	18	45 mm	26.5 mm		Heavy duty	
171986	Pkg. 10	24	25	45 mm	26.5 mm		Heavy duty		

Jahn

	HC-CARGO	Std. pkg.	Voltage	Watt	Length	OD	Colour	Type	Comment
 BAU15s	170648	Pkg. 10	12	21	52.5 mm	26.5 mm	Orange	PY21W	

Parking and Flasher - Position

	HC-CARGO	Std. pkg.	Voltage	Watt	Length	OD	Colour	Type	Comment
 BA15S	171981	Pkg. 10	6	5	35 mm	18.5 mm			
	171993	Pkg. 10	6	10	35 mm	18.5 mm			
	171983	Pkg. 10	6	18	45 mm	26.5 mm			
	171980	Pkg. 10	12	5	35 mm	18.5 mm		Longlife	







Conventional

	HC-CARGO	Std. pkg.	Voltage	Watt	Length	OD	Colour	Type	Comment
 BA15S	171991	Pkg. 10	12	45	53 mm	36 mm		Conventional	For US and UK systems.
	171978	Pkg. 1	24	45	53 mm	36 mm		Conventional, Heavy duty	For US and UK systems.
 BA20d	171977	Pkg. 1	6	3535	70 mm	36 mm		Conventional	
	171985	Pkg. 1	12	2525	70 mm	36 mm		Conventional	
	171975	Pkg. 1	12	3535	70 mm	36 mm		Conventional	
	171974	Pkg. 1	12	4540	70 mm	36 mm		Conventional	
	171976	Pkg. 1	24	4540	70 mm	36 mm		Conventional, Heavy duty	

Halogen

	HC-CARGO	Std. pkg.	Voltage	Watt	Length	OD	Colour	Type	Comment
 BA15S	171987	Pkg. 10	12	10	37.5 mm	10 mm		Halogen	

LED

	HC-CARGO	Std. pkg.	Voltage	Watt	Length	OD	Colour	Type	Comment
 BA15S	172162	Pkg. 1	12	13			Yellow		
	172163	Pkg. 1	24	7			White		
	172164	Pkg. 1	24	7			White		
	172165	Pkg. 1	24	7			Red		
	172166	Pkg. 1	24	7			Yellow		
 BA9s	172170	Pkg. 1	12	4			White		
	172171	Pkg. 1	24	2			White		
 BAX9s	172182	Pkg. 1	12	23			White		CANBUS.
 BAY15d	172167	Pkg. 1	12	13			Red		
	172168	Pkg. 1	12	13			White		
	172169	Pkg. 1	24	7			White		
 KW2.1x9.5d	172176	Pkg. 1	24	1			Yellow		
	172174	Pkg. 1	24	2			Red		
	172175	Pkg. 1	24	2			White		
 SV8.5	172179	Pkg. 1	12	2	38 mm	11 mm	Red		
	172180	Pkg. 1	12	2	38 mm	11 mm	Blue		
	172181	Pkg. 1	12	2	38 mm	11 mm	White		
	172177	Pkg. 1	24	1	38 mm	11 mm	Red		
	172178	Pkg. 1	24	1	38 mm	11 mm	White		
 W2.1x9.5d	172173	Pkg. 1	12	2			Yellow		
	172172	Pkg. 1	12	4			White		

John

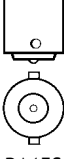
	HC-CARGO	Std. pkg.	Voltage	Watt	Length	OD	Colour	Type	Comment
 BA15S	172159	Pkg. 1	12	4			White		
	172157	Pkg. 1	12	13			Yellow		
	172160	Pkg. 1	12	13			White		
	172161	Pkg. 1	12	13			Red		





Electrical Components

Edition 2017/2018



ELECTRICAL PARTS & ENGINE MANAGEMENT

CABIN HEATERS

060242 Cabin Heater 24 V Std pkg 1			Voltage: 24 Watt/speed: 24	Dim.: 267x106x135 mm Water connection OD: 12 mm Capacity kW/speed: 1.9 Airflow speed: 76 m ³ /h	Cabinet: Steel
060243 Cabin Heater 12 V Std pkg 1			Voltage: 12 Watt/speed: 50	Dim.: 333x163x100 mm Water connection OD: 16 mm Capacity kW/speed 1: 3.6 Airflow speed 1: 144 m ³ /h Capacity kW/speed 2: 5.1 Airflow speed 2: 216 m ³ /h	Cabinet: Steel
060244 Cabin Heater 24 V Std pkg 1			Voltage: 24 Watt/speed: 50	Dim.: 333x163x100 mm Water connection OD: 16 mm Capacity kW/speed 1: 3.6 Airflow speed 1: 144 m ³ /h Capacity kW/speed 2: 5.1 Airflow speed 2: 216 m ³ /h	Cabinet: Steel
060245 Cabin Heater 12 V Std pkg 1			Voltage: 12 Watt/speed: 250	Dim.: 440x234x163 mm Water connection OD: 16 mm Capacity kW/speed 1: 5.5 Airflow speed 1: 216 m ³ /h Capacity kW/speed 2: 10.3 Airflow speed 2: 480 m ³ /h	Cabinet: Steel
060246 Cabin Heater 24 V Std pkg 1			Voltage: 24 Watt/speed: 250	Dim.: 440x234x163 mm Water connection OD: 16 mm Capacity kW/speed 1: 5.5 Airflow speed 1: 216 m ³ /h Capacity kW/speed 2: 10.3 Airflow speed 2: 480 m ³ /h	Cabinet: Steel
060247 Cabin Heater 12 V Std pkg 1			Voltage: 12 Watt/speed 1: 60 Watt/speed 2: 77 Watt/speed 3: 114	Dim.: 365x235x130 mm Water connection OD: 16 mm Capacity kW/speed 1: 7.2 Airflow speed 1: 264 m ³ /h Capacity kW/speed 2: 9.3 Airflow speed 2: 357 m ³ /h Capacity kW/speed 3: 12.2 Airflow speed 3: 504 m ³ /h	Cabinet: Steel
060248 Cabin Heater 12 V Std pkg 1			Voltage: 12 Watt/speed: 30	Dim.: 193x171x140 mm Airflow speed: 126 m ³ /h	Cabinet: Steel

		EL. SPECIFICATIONS	DIMENSIONS	ADDITIONAL SPECIFICATIONS
060249	Cabin Heater 12 V Std pkg 1	 Voltage: 12 Watt/speed: 75	Dim.: 273x199x114 mm Water connection OD: 16 mm Capacity kW/speed: 4.3 Airflow speed: 230 m ³ /h	Cabinet: Plastic
060250	Cabin Heater 24 V Std pkg 1	 Voltage: 24 Watt/speed: 75	Dim.: 273x199x114 mm Water connection OD: 16 mm Capacity kW/speed: 4.3 Airflow speed: 230 m ³ /h	Cabinet: Plastic
060251	Cabin Heater 24 V Std pkg 1	 Voltage: 24 Watt/speed: 75	Dim.: 273x199x114 mm Water connection OD: 16 mm Capacity kW/speed: 4.3 Airflow speed: 230 m ³ /h	Cabinet: Plastic
060252	Cabin Heater 48 V Std pkg 1	 Voltage: 48 Watt/speed: 900	Dim.: 219x121.5x80 mm Airflow speed: 70 m ³ /h	Cabinet: Steel
060253	Cabin Heater 80 V Std pkg 1	 Voltage: 80 Watt/speed 1: 900	Dim.: 219x121.5x80 mm Airflow speed: 70 m ³ /h	Cabinet: Steel
060254	Cabin Heater 12 V Std pkg 1	 Voltage: 12 Watt/speed 1: 420	Dim.: 219x121.5x80 mm Airflow speed: 70 m ³ /h	Cabinet: Steel
060255	Cabin Heater 24 V Std pkg 1	 Voltage: 24 Watt/speed 1: 750	Dim.: 219x121.5x80 mm Airflow speed: 70 m ³ /h	Cabinet: Steel

060264 Cabin Heater 12 V Std pkg 1

Heat-On 1541-12.

Voltage: 12
Watt/speed 1: 50

Dim.: 172x172x150 mm
Water connection OD: 16 mm
Capacity kW/speed 1: 5.5
Airflow speed 1: 273 m³/h
Capacity kW/speed 2: 6
Airflow speed 2: 360 m³/h

Cabinet: Steel

060265 Cabin Heater 24 V Std pkg 1

Heat-On 1541-24.

Voltage: 24
Watt/speed 1: 50

Dim.: 172x172x150 mm
Water connection OD: 16 mm
Capacity kW/speed 1: 5.5
Airflow speed 1: 273 m³/h
Capacity kW/speed 2: 6
Airflow speed 2: 360 m³/h

Cabinet: Steel

060266 Cabin Heater 12 V Std pkg 1

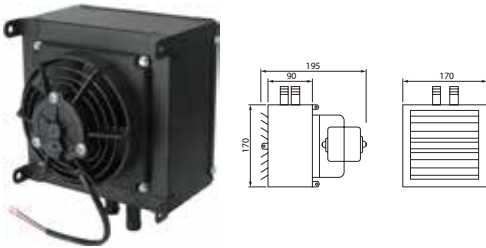
Heat-On 1650-12.

Voltage: 12
Watt/speed 1: 24

Dim.: 195x170x170 mm
Water connection OD: 16 mm
Capacity kW/speed: 5.1
Airflow speed: 250 m³/h

Cabinet: Steel

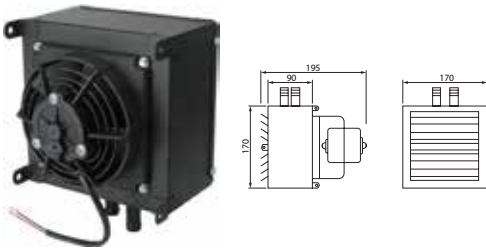
060267 Cabin Heater 24 V Std pkg 1

Heat-On 1650-24.

Voltage: 24
Watt/speed 1: 24

Dim.: 195x170x170 mm
Water connection OD: 16 mm
Capacity kW/speed: 5.1
Airflow speed: 250 m³/h

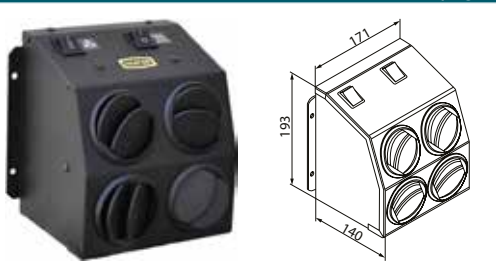
Cabinet: Steel

060270 Cabin Heater 12 V Std pkg 1

Voltage: 12
Watt/speed 1: 396

Dim.: 193x171x140 mm
Airflow speed: 126 m³/h

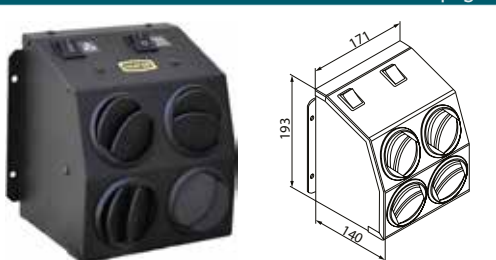
Cabinet: Galvanized steel w/
 black polyester

060271 Cabin Heater 12 V Std pkg 1

Voltage: 12
Watt/speed 1: 624

Dim.: 193x171x140 mm
Airflow speed: 126 m³/h

Cabinet: Galvanized steel w/
 black polyester

CONNECTORS			
060260 Air Vent	Std pkg 1		Dim.: 96x63x63 mm
060261 Air Vent	Std pkg 1		Dim.: 96x63x63 mm
060262 Round Air Ven	Std pkg 1		ID: 73.5 mm OD: 101 mm
ACCESSORIES			
060256 Demister Tube 40mm	Std pkg 1		ID/demister tube connection: 40 mm Length: 100 cm Material: PVC
060257 Demister Tube 45mm	Std pkg 1		ID/demister tube connection: 45 mm Length: 100 cm Material: PVC
060258 Demister Tube 50mm	Std pkg 1		ID/demister tube connection: 50 mm Length: 100 cm Material: PVC
060259 Demister Tube 75mm	Std pkg 1		ID/demister tube connection: 75 mm Length: 100 cm Material: PVC
060263 Water Valve	Std pkg 1		ID/demister tube connection: 12 mm Length: 8.5 cm

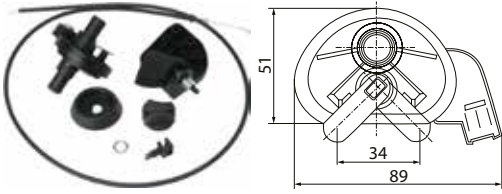
060268 Water Valve Std pkg 1
Heat-On 340.06.021.



ID/demister tube connection: 16 mm

060269 Rubber bend Std pkg 1
Heat-On 1518-2A.



ID/demister tube connection: 40 mm

181673 Rocker Switch Std pkg 1 Servicing: HC-CARGO 060243, 060244, 060248, 060270, 060271



181674 Rotating Switch Std pkg 1



Amp: 20

181676 Rocker Switch Std pkg 1 Servicing: HC-CARGO 060248



CAMERA & PARKING SENSORS
CCTV REAR OBSERVATION SYSTEM

161051 Rear Observation Kit Std pkg 1

Monitor Mounting, w/suction Cup: HC-CARGO 161044. Consists: 1x7" monitor: HC-CARGO 161052. 1x colour camera: HC-CARGO 161043. 1x20 m extension cable: HC-CARGO 160888. Accessories: HC-CARGO 161006, 161029, 161030, 161041, 161056, 161057, 160889, 161053.

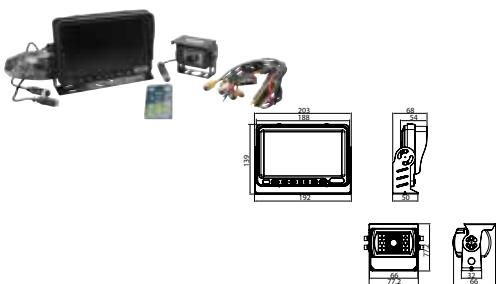

Voltage: 12-24

Extension cable: 20 m
Display size: 7"
Wide angle: 120°

Monitor: TFT-LCD
Type: Camera kit
Camera type: Colour
No./cameras: max. 4
Remote control: w/
Audio: Yes
Infrared: w/
Split screen: Yes
Tightness norm: IP 69K (Camera)
Language: Chinese, German, English, French, Dutch, Italian, Spanish, Danish, Russian, Polish

161054 Rear Observation Kit Std pkg 1

Monitor Mounting, w/suction Cup: HC-CARGO 161044. Aerial: HC-CARGO 161036. Consists: 1x5" monitor: HC-CARGO 161055. 2x colour camera: HC-CARGO 161058.

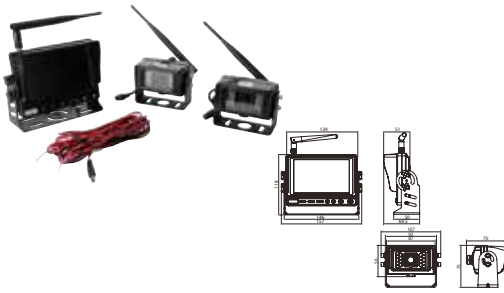

Voltage: 12-24

Display size: 5"
Max wide transmission range: 30 m
Wide angle: 120°

Monitor: TFT-LCD
Type: Camera kit
Camera type: Colour - Wireless
No./cameras: 2
Audio: Yes
Infrared: w/
Split screen: Yes
Tightness norm: IP 69K (Camera)
Language: English

CAMERAS

161058 Colour Camera Std pkg 1 Servicing: HC-CARGO 161054

Aerial: HC-CARGO 161036.

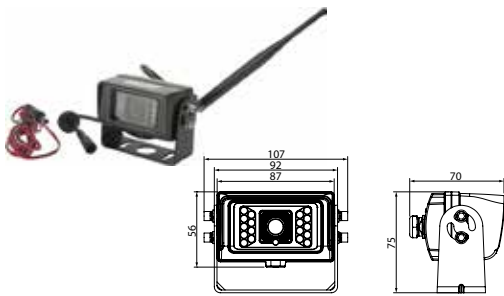

Voltage: 12-24
Light sensitivity: 0 lux

Connection cable: 4 pin
Height: 75 mm
Depth: 70 mm
Width: 107 mm
Resolution: 500 TV lines
Wide angle: 120°

Signal system: PAL/NTSC
Type: Colour - Wireless
Colour: Black
Material: Aluminium
Picture sensor: 1/3" CMOS
Audio: No
Infrared: w/
Mirror function: w/
Connection cable: 4 pin
Protection degree: IP 69K

MONITORS

161052 Monitor Std pkg 1 Servicing: HC-CARGO 161051

Monitor Mounting, w/suction Cup: HC-CARGO 161044.

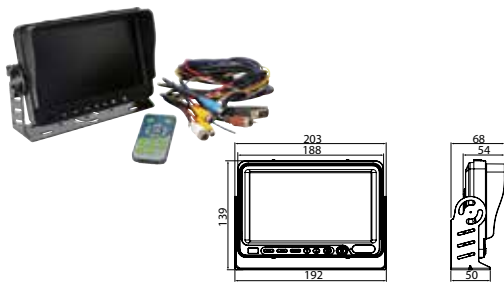

Voltage: 12-24

Height: 139 mm
Depth: 68 mm
Width: 203 mm
Display size: 7"
Resolution: 800x480 pixels

Type: TFT-LCD
Camera type: Colour
Mount. bracket: w/
Loudspeaker: Yes
Audio: Yes
Mirror function: w/
Language: Chinese, German, English, French, Dutch, Italian, Spanish, Danish, Russian, Polish

161053 Monitor Std pkg 1 Servicing: HC-CARGO 161051

Monitor Mounting, w/suction Cup: HC-CARGO 161044.

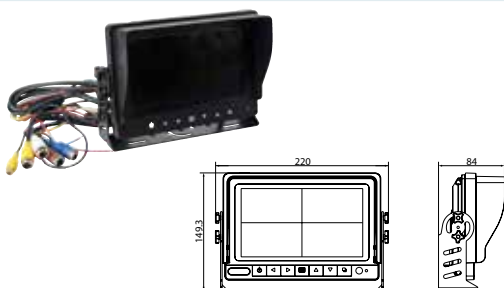

Voltage: 12-24

Height: 149.3 mm
Depth: 84 mm
Width: 220 mm
Display size: 7"
Resolution: 800x480 pixels

Type: TFT-LCD
Camera type: Colour
Audio: No
Mirror function: w/
Protection degree: IP 69K
Language: English

161055 Monitor Std pkg 1 Servicing: HC-CARGO 161054

Monitor Mounting, w/suction Cup: HC-CARGO 161044. Aerial: HC-CARGO 161036.

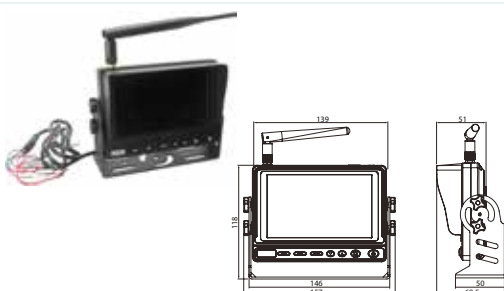

Voltage: 12-24

Height: 118 mm
Depth: 69.5 mm
Width: 157 mm
Display size: 5"
Resolution: 800x480 pixels

Type: TFT-LCD
Camera type: Colour - Wireless
Mount. bracket: w/
Audio: No
Mirror function: w/
Language: English

FANS & BLOWERS

FAN/HEATER MOTORS

SINGLE SHAFTS

161712 Universal Motor

Std pkg 1

Servicing: Carrier 54-00639-114



Voltage: 12

OD: 65 mm
Shaft dia.: 7 mm
Length: 118 mm
Speed: 1-speed

No./shafts: 1
Fan mounted: No
Complete w/housing: No

161718 Universal Motor

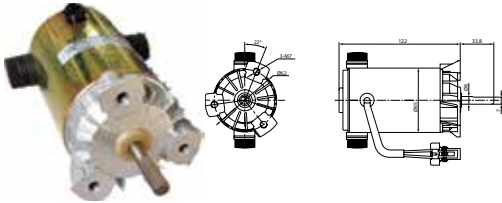
Std pkg 1

Voltage: 12

OD: 65 mm
Shaft dia.: 8 mm
Length: 122 mm
Speed: 1-speed

No./shafts: 1
Fan mounted: No
Complete w/housing: No

DASHBOARD GAUGES

AMMETER

161716 Ammeter

Std pkg 1

Servicing: HC-CARGO 181679, 181680, 181681

Mounting hole: 29 mm. 6.3 mm terminals.

Voltage: 12/24

ID: 26.4 mm
OD: 36.8 mm

Mount. type: Built-in
Colour: Black
Measuring range: 0-20
Measuring unit: A
Digital: Yes

VOLTMETER

161714 Voltmeter

Std pkg 1

Servicing: HC-CARGO 181679, 181680, 181681

Mounting hole: 29 mm. 6.3 mm terminals.

Voltage: 6-33

ID: 26.4 mm
OD: 36.8 mm

Mount. type: Built-in
Colour: Black
Measuring range: 0-36
Measuring unit: V
Digital: Yes

161715 Voltmeter

Std pkg 1

Servicing: HC-CARGO 181679, 181680, 181681

Mounting hole: 29 mm. 6.3 mm terminals.

Voltage: 12/24

ID: 26.4 mm
OD: 36.8 mm mm

Mount. type: Built-in
Colour: Black
Measuring range: 11--32V
Measuring unit: V
Digital: Yes

POWER MANAGEMENT COMPONENTS

CHARGERS

161122 Charger

Std pkg 1

Voltage: 220/240
Amp: 10
Hertz: 50/60

Dim.: 210x98x60 mm
Working temp.: -20 - +50 °C

Approvals: CE

BATTERY ISOLATORS
161059 Split Charge Relay 12V Std pkg 1

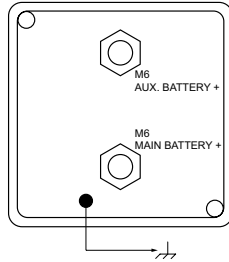
Microprocessor-controlled relay. Opens for charging the secondary battery when charger voltage reaches 12.8 V and closes at 13.3 V.

Voltage: 12
Current/max Amp: 140

Dim.: 67x67x50 mm

No./batteries: 2
Comp. diode: No

VOLTAGE CONVERTERS
INSULATED
161079 Voltage Converter Std pkg 1

Voltage/in: 24
Voltage/out: 12
Amp/5 min.: 22
Amp/cont.: 18

Dim.: 217x87x50 mm

Type: Switch mode/isolated
Protection against over current: Yes
Protection against over heating: Yes
Protection against overvoltage: Yes
Protection against reverse connection: Yes
Protection against transients: Yes
Approvals: CE

161081 Voltage Converter Std pkg 1

Voltage/in: 24
Voltage/out: 12
Amp/cont.: 24

Dim.: 217x87x50 mm

Type: Switch mode/isolated
Protection against over current: Yes
Protection against over heating: Yes
Protection against overvoltage: Yes
Protection against reverse connection: Yes
Protection against transients: Yes
Approvals: CE

NON INSULATED
161072 Voltage Converter Std pkg 1

Voltage/in: 12
Voltage/out: 24
Amp/cont.: 16
Watt/out: 400

Dim.: 233x125x74 mm

Type: Switch mode/uninsulated
Protection against over current: Yes
Protection against over heating: Yes
Protection against overvoltage: Yes
Protection against reverse connection: Yes
Protection against transients: Yes
Approvals: CE

161073 Voltage Converter Std pkg 1

Voltage/in: 12
Voltage/out: 24
Amp/cont.: 25
Watt/out: 600

Dim.: 283x125x74 mm

Type: Switch mode/uninsulated
Protection against over current: Yes
Protection against over heating: Yes
Protection against overvoltage: Yes
Protection against reverse connection: Yes
Protection against transients: Yes
Approvals: CE

161080 Voltage Converter Std pkg 1

Voltage/in: 24
Voltage/out: 12
Amp/5 min.: 22
Amp/cont.: 18

Dim.: 167x87x50 mm

Type: Switch mode/uninsulated
Protection against over current: Yes
Protection against over heating: Yes
Protection against overvoltage: Yes
Protection against reverse connection: Yes
Protection against transients: Yes
Approvals: CE

VOLTAGE INVERTERS
161078 Voltage Inverter Std pkg 1

Voltage/in: 12
Voltage/out: 220-240
Alarm/Voltage: 11±0.5
Shut down/Voltage: 10±0.5
Amp/max/cont.: 15
Amp/standby: <0.28
Watt/cont.: 150
Watt/max.: 450

Dim.: 120x73x73 mm
Temp.: 60°C±5°C
Efficiency: 90 %

Type: Modified sine
Over heating: Yes
Overloading: Yes
Short circuit: Yes
Approvals: CE
Alternativ no.: 160541

161083 Voltage Inverter UK Std pkg 1

UK version.



Voltage/in: 12
Voltage/out: 220-240
Alarm/Voltage: 11±0.5
Shut down/Voltage: 10±0.5
Amp/max/cont.: 15
Amp/standby: <0.28
Watt/cont.: 150
Watt/max.: 450

Dim.: 120x73x73 mm
Temp.: 60°C±5°C
Efficiency: 90 %

Type: Modified sine
Over heating: Yes
Overloading: Yes
Short circuit: Yes
Approvals: CE

161084 Voltage Inverter - UK Std pkg 1

UK version.



Voltage/in: 24
Voltage/out: 220-240
Alarm/Voltage: 22±1
Shut down/Voltage: 20±1
Amp/max/cont.: 8
Amp/standby: <0.18
Watt/cont.: 150
Watt/max.: 450

Dim.: 120x73x73 mm
Temp.: 60°C±5°C
Efficiency: 90 %

Type: Modified sine
Over heating: Yes
Overloading: Yes
Short circuit: Yes
Approvals: CE

161085 Voltage Inverter Std pkg 1

Voltage/in: 12
Voltage/out: 220-240
Alarm/Voltage: 10.5±0.5
Shut down/Voltage: 10±0.5
Amp/max/cont.: 30
Amp/standby: <0.5
Watt/cont.: 300
Watt/max.: 900

Dim.: 155x73x73 mm
Temp.: 60°C±5°C
Efficiency: 90 %

Type: Modified sine
Over heating: Yes
Overloading: Yes
Short circuit: Yes
Approvals: CE
Alternativ no.: 160543

161087 Voltage Inverter UK Std pkg 1

UK version.



Voltage/in: 12
Voltage/out: 220-240
Alarm/Voltage: 10.5±0.5
Shut down/Voltage: 10±0.5
Amp/max/cont.: 30
Amp/standby: <0.5
Watt/cont.: 300
Watt/max.: 900

Dim.: 155x73x73 mm
Temp.: 60°C±5°C
Efficiency: 90 %

Type: Modified sine
Over heating: Yes
Overloading: Yes
Short circuit: Yes
Approvals: CE

161088 Voltage Inverter UK Std pkg 1

UK version.



Voltage/in: 24
Voltage/out: 220-240
Alarm/Voltage: 21±1
Shut down/Voltage: 20±1
Amp/max/cont.: 15
Amp/standby: <0.5
Watt/cont.: 300
Watt/max.: 900

Dim.: 155x73x73 mm
Temp.: 60°C±5°C
Efficiency: 90 %







Type: Modified sine
Over heating: Yes
Overloading: Yes
Short circuit: Yes
Approvals: CE

161089 Voltage Inverter Std pkg 1

Voltage/in: 12
Voltage/out: 220-240
Alarm/Voltage: 10.5±0.5
Shut down/Voltage: 10±0.5
Amp/max/cont.: 60
Amp/standby: <0.6
Watt/cont.: 600
Watt/max.: 1500

Dim.: 190x113x62 mm
Temp.: 60°C±5°C
Efficiency: 85-90 %

Type: Modified sine
Over heating: Yes
Overloading: Yes
Short circuit: Yes
Approvals: CE
Alternativ no.: 160545

161091 Voltage Inverter UK Std pkg 1 <i>UK version.</i>			
	Voltage/in: 12 Voltage/out: 220-240 Alarm/Voltage: 10.5±0.5 Shut down/Voltage: 10±0.5 Amp/max/cont.: 60 Amp/standby: <0.6 Watt/cont.: 600 Watt/max.: 1500	Dim.: 190x113x62 mm Temp.: 60°C±5°C Efficiency: 85-90 %	Type: Modified sine Over heating: Yes Overloading: Yes Short circuit: Yes Approvals: CE Alternativ no.: 161704
161092 Voltage Inverter UK Std pkg 1 <i>UK version.</i>			
	Voltage/in: 24 Voltage/out: 220-240 Alarm/Voltage: 21±1 Shut down/Voltage: 20±1 Amp/max/cont.: 30 Amp/standby: <0.4 Watt/cont.: 600 Watt/max.: 1500	Dim.: 190x113x62 mm Temp.: 60°C±5°C Efficiency: 85-90 %	Type: Modified sine Over heating: Yes Overloading: Yes Short circuit: Yes Approvals: CE
161093 Voltage Inverter Std pkg 1 <i>Remote control: HC-CARGO 161713.</i>			
	Voltage/in: 12 Voltage/out: 220-240 Alarm/Voltage: 10.5±0.5 Shut down/Voltage: 10±0.5 Amp/max/cont.: 100 Amp/standby: <0.6 Watt/cont.: 1000 Watt/max.: 2400	Dim.: 340x135x79 mm Temp.: 60°C±5°C Efficiency: 85-90 %	Type: Modified sine Over heating: Yes Overloading: Yes Short circuit: Yes Approvals: CE Alternativ no.: 160660
161095 Voltage Inverter UK Std pkg 1 <i>UK version. Remote control: HC-CARGO 161713.</i>			
	Voltage/in: 12 Voltage/out: 220-240 Alarm/Voltage: 10.5±0.5 Shut down/Voltage: 10±0.5 Amp/max/cont.: 100 Amp/standby: <0.6 Watt/cont.: 1000 Watt/max.: 2400	Dim.: 340x135x79 mm Temp.: 60°C±5°C Efficiency: 85-90 %	Type: Modified sine Over heating: Yes Overloading: Yes Short circuit: Yes Approvals: CE Alternativ no.: 161707
161096 Voltage Inverter UK Std pkg 1 <i>UK version. Remote control: HC-CARGO 161713.</i>			
	Voltage/in: 24 Voltage/out: 220-240 Alarm/Voltage: 21±1 Shut down/Voltage: 20±1 Amp/max/cont.: 50 Amp/standby: <0.5 Watt/cont.: 1000 Watt/max.: 2400	Dim.: 340x135x79 mm Temp.: 60°C±5°C Efficiency: 85-90 %	Type: Modified sine Over heating: Yes Overloading: Yes Short circuit: Yes Approvals: CE Alternativ no.: 160676UK
161097 Voltage Inverter Std pkg 1 <i>Remote control: HC-CARGO 161713.</i>			
	Voltage/in: 12 Voltage/out: 220-240 Alarm/Voltage: 10.5±0.5 Shut down/Voltage: 10±0.5 Amp/max/cont.: 150 Amp/standby: <0.7 Watt/cont.: 1500 Watt/max.: 3000	Dim.: 400x135x79 mm Temp.: 60°C±5°C Efficiency: 85-90 %	Type: Modified sine Over heating: Yes Overloading: Yes Short circuit: Yes Approvals: CE Alternativ no.: 160569
161099 Voltage Inverter UK Version Std pkg 1 <i>UK version. Remote control: HC-CARGO 161713.</i>			
	Voltage/in: 12 Voltage/out: 220-240 Alarm/Voltage: 10.5±0.5 Shut down/Voltage: 10±0.5 Amp/max/cont.: 150 Amp/standby: <0.7 Watt/cont.: 1500 Watt/max.: 3000	Dim.: 400x135x79 mm Temp.: 60°C±5°C Efficiency: 85-90 %	Type: Modified sine Over heating: Yes Overloading: Yes Short circuit: Yes Approvals: CE Alternativ no.: 161705

161100 Voltage Inverter UK Version Std pkg 1

UK version. Remote control: HC-CARGO 161713.



Voltage/in: 24
 Voltage/out: 220-240
 Alarm/Voltage: 21±1
 Shut down/Voltage: 20±1
 Amp/max/cont.: 75
 Amp/standby: <0.6
 Watt/cont.: 1500
 Watt/max.: 3000

Dim.: 400x135x79 mm
 Temp.: 60°C±5°C
 Efficiency: 85-90 %

Type: Modified sine
 Over heating: Yes
 Overloading: Yes
 Short circuit: Yes
 Approvals: CE
 Alternativ no.: 161706

161101 Voltage Inverter Std pkg 1

Remote control: HC-CARGO 161713.



Voltage/in: 12
 Voltage/out: 220-240
 Alarm/Voltage: 10.5±0.5
 Shut down/Voltage: 10±0.5
 Amp/max/cont.: 70
 Amp/standby: <0.9
 Watt/cont.: 700
 Watt/max.: 1400

Dim.: 340x135x79 mm
 Temp.: 60°C±5°C
 Efficiency: >85 %

Type: Sinus
 Over heating: Yes
 Overloading: Yes
 Short circuit: Yes
 Approvals: CE

161103 Voltage Inverter UK Std pkg 1

UK version. Remote control: HC-CARGO 161713.



Voltage/in: 12
 Voltage/out: 220-240
 Alarm/Voltage: 10.5±0.5
 Shut down/Voltage: 10±0.5
 Amp/max/cont.: 70
 Amp/standby: <0.9
 Watt/cont.: 700
 Watt/max.: 1400

Dim.: 340x135x79 mm
 Temp.: 60°C±5°C
 Efficiency: >85 %

Type: Sinus
 Over heating: Yes
 Overloading: Yes
 Short circuit: Yes
 Approvals: CE

161104 Voltage Inverter UK Std pkg 1

UK version. Remote control: HC-CARGO 161713.



Voltage/in: 24
 Voltage/out: 220-240
 Alarm/Voltage: 21±1
 Shut down/Voltage: 20±1
 Amp/max/cont.: 35
 Amp/standby: <0.6
 Watt/cont.: 700
 Watt/max.: 1400

Dim.: 340x135x79 mm
 Temp.: 60°C±5°C
 Efficiency: >85 %

Type: Sinus
 Over heating: Yes
 Overloading: Yes
 Short circuit: Yes
 Approvals: CE

161105 Voltage Inverter Std pkg 1

Remote control: HC-CARGO 161713.



Voltage/in: 12
 Voltage/out: 220-240
 Alarm/Voltage: 10.5±0.5
 Shut down/Voltage: 10±0.5
 Amp/max/cont.: 110
 Amp/standby: <1.3
 Watt/cont.: 1000
 Watt/max.: 2000

Dim.: 360x195x80 mm
 Temp.: 60°C±5°C
 Efficiency: >85 %

Type: Sinus
 Over heating: Yes
 Overloading: Yes
 Short circuit: Yes
 Approvals: CE

161107 Voltage Inverter UK Std pkg 1

UK version. Remote control: HC-CARGO 161713.



Voltage/in: 12
 Voltage/out: 220-240
 Alarm/Voltage: 10.5±0.5
 Shut down/Voltage: 10±0.5
 Amp/max/cont.: 110
 Amp/standby: <1.3
 Watt/cont.: 1000
 Watt/max.: 2000

Dim.: 360x195x80 mm
 Temp.: 60°C±5°C
 Efficiency: >85 %

Type: Sinus
 Over heating: Yes
 Overloading: Yes
 Short circuit: Yes
 Approvals: CE

161108 Voltage Inverter UK Std pkg 1







UK version. Remote control: HC-CARGO 161713.



Voltage/in: 24
 Voltage/out: 220-240
 Alarm/Voltage: 21±1
 Shut down/Voltage: 20±1
 Amp/max/cont.: 55
 Amp/standby: <1
 Watt/cont.: 1000
 Watt/max.: 2000

Dim.: 360x195x80 mm
 Temp.: 60°C±5°C
 Efficiency: >85 %

Type: Sinus
 Over heating: Yes
 Overloading: Yes
 Short circuit: Yes
 Approvals: CE

161109 Voltage Inverter Std pkg 1 <i>Remote control: HC-CARGO 161713.</i>			
	Voltage/in: 12 Voltage/out: 220-240 Alarm/Voltage: 10.5±0.5 Shut down/Voltage: 10±0.5 Amp/max/cont.: 160 Amp/standby: <1.3 Watt/cont.: 1500 Watt/max.: 3000	Dim.: 430x245x85 mm Temp.: 60°C±5°C Efficiency: >85 %	Type: Sinus Over heating: Yes Overloading: Yes Short circuit: Yes Approvals: CE
161111 Voltage Inverter UK Std pkg 1 <i>UK version. Remote control: HC-CARGO 161713.</i>			
	Voltage/in: 12 Voltage/out: 220-240 Alarm/Voltage: 10.5±0.5 Shut down/Voltage: 10±0.5 Amp/max/cont.: 160 Amp/standby: <1.3 Watt/cont.: 1500 Watt/max.: 3000	Dim.: 430x245x85 mm Temp.: 60°C±5°C Efficiency: >85 %	Type: Sinus Over heating: Yes Overloading: Yes Short circuit: Yes Approvals: CE
161112 Voltage Inverter UK Std pkg 1 <i>UK version. Remote control: HC-CARGO 161713.</i>			
	Voltage/in: 24 Voltage/out: 220-240 Alarm/Voltage: 21±1 Shut down/Voltage: 20±1 Amp/max/cont.: 80 Amp/standby: <1 Watt/cont.: 1500 Watt/max.: 3000	Dim.: 430x245x85 mm Temp.: 60°C±5°C Efficiency: >85 %	Type: Sinus Over heating: Yes Overloading: Yes Short circuit: Yes Approvals: CE
161113 Voltage Inverter Std pkg 1 <i>Remote control: HC-CARGO 161713.</i>			
	Voltage/in: 12 Voltage/out: 220-240 Alarm/Voltage: 10.5±0.5 Shut down/Voltage: 10±0.5 Amp/max/cont.: 250 Amp/standby: <0.8 Watt/cont.: 2500 Watt/max.: 5000	Dim.: 340x135x148 mm Temp.: 60°C±5°C Efficiency: 85-90 %	Type: Modified sine Over heating: Yes Overloading: Yes Short circuit: Yes Approvals: CE
161115 Voltage Inverter UK Std pkg 1 <i>UK version. Remote control: HC-CARGO 161713.</i>			
	Voltage/in: 12 Voltage/out: 220-240 Alarm/Voltage: 10.5±0.5 Shut down/Voltage: 10±0.5 Amp/max/cont.: 250 Amp/standby: <0.8 Watt/cont.: 2500 Watt/max.: 5000	Dim.: 340x135x148 mm Temp.: 60°C±5°C Efficiency: 85-90 %	Type: Modified sine Over heating: Yes Overloading: Yes Short circuit: Yes Approvals: CE
161116 Voltage Inverter UK Std pkg 1 <i>UK version. Remote control: HC-CARGO 161713.</i>			
	Voltage/in: 24 Voltage/out: 220-240 Alarm/Voltage: 21±1 Shut down/Voltage: 20±1 Amp/max/cont.: 125 Amp/standby: <0.7 Watt/cont.: 2500 Watt/max.: 5000	Dim.: 340x135x148 mm Temp.: 60°C±5°C Efficiency: 85-90 %	Type: Modified sine Over heating: Yes Overloading: Yes Short circuit: Yes Approvals: CE
ACCESSORIES			
Servicing: HC-CARGO 161093, 161094, 161095, 161096, 161097, 161098, 161099, 161100, 161101, 161102, 161103, 161104, 161105, 161106, 161107, 161108, 161109, 161110, 161111, 161112, 161113, 161114, 161115, 161116			
161713 Remote control Std pkg 1			
			

VOLTAGE REDUCER

161042 Voltage Reducer Std pkg 1

Protects electronics against voltage peaks.



Voltage: 12 - 14

ID/mount. hole: 8 mm
Length: 27 mm
Width: 33 mm

PUMPS & PUMP PARTS

ELECTRICAL FUEL PUMPS

INTERRUPTER PUMPS

070214 Fuel Pump Std pkg 1

w/ integral filter.



Voltage: 12

Thread: 1/8-27 INT
Capacity: 150-227 l/h
Pressure: 9-11.5 PSI

Fuel: Gasoline, diesel, ethanol, methanol
Type: Universal

SWITCHES

BATTERY SWITCHES

181687 Battery Main Switch Std pkg 1 Servicing: HC-CARGO 181679, 181680, 181681

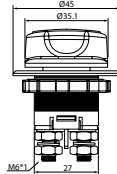
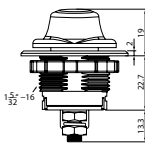

Voltage: <32
Amp/5 sec.: 500
Amp/cont.: 100

Dist. mount. holes:
27 mm

Type: Battery
Material: PBT
No./mounting holes: 2
No./poles: 2
Key: No

WIPER SYSTEMS

WIPER BLADES

INDUSTRIAL

Dim.: 8x2/8x2.5 mm

Used on: Tractors



HC-CARGO

Std pkg

Length

Type

160028

Pkg. 1

330 mm

13"

For flat glass

160035

Pkg. 1

350 mm

14"

For flat glass

160025

Pkg. 1

360 mm

14"

For flat glass

WIPER ARMS

MOUNTING PARTS

160727 K-Connector Std pkg 1 Servicing: HC-CARGO 160338



Used on: Trucks



Workshop Consumables

Edition 2017/2018



BATTERY TERMINALS

QUICK RELEASE TERMINAL

193369 Quick release terminal + Std pkg 1

Negative: HC-CARGO 193370.

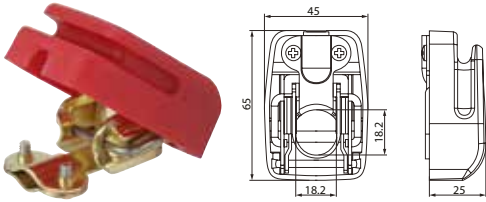
Dim.: 26x46x65.5 mm
ID: 18.8 mm
Angled: 0-45°
Polarity: Positive

Colour: Red
Material: Copper
Tin plated: No
Pcs.: 1
Alternativ no.: 193371

193370 Quick release terminal - Std pkg 1

Positive: HC-CARGO 193369.

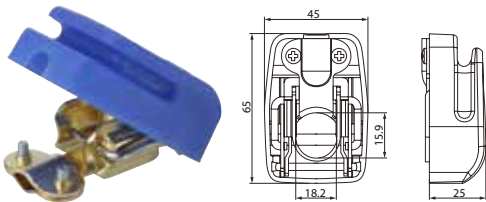
Dim.: 26x46x65.5 mm
ID: 18.5 mm
Angled: 0-45°
Polarity: Negative

Colour: Blue
Material: Copper
Tin plated: No
Pcs.: 1
Alternativ no.: 193372

193371 Quick release terminal + Std pkg 1

Negative: HC-CARGO 193372.

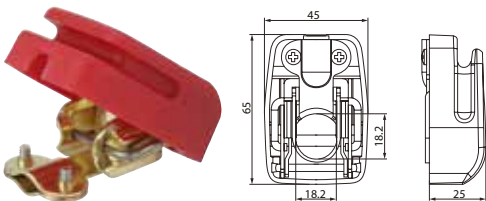
Dim.: 26x46x65.5 mm
ID: 18.8 mm
Angled: 0-45°
Polarity: Positive

Colour: Red
Material: Copper
Tin plated: No
Pcs.: 25
Alternativ no.: 193369

193372 Quick release terminal - Std pkg 1

Positive: HC-CARGO 193371.

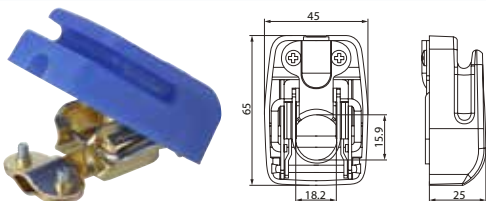
Dim.: 26x46x65.5 mm
ID: 18.5 mm
Angled: 0-45°
Polarity: Negative

Colour: Blue
Material: Copper
Tin plated: No
Pcs.: 25
Alternativ no.: 193370

PLUGS & SOCKETS

ADAPTERS 12 V

7-13 PIN

181677 Trailer Adapter Std pkg 1

Voltage: 12

Plug 1: 7
Plug 2: 13
ISO norm 1: 1724
ISO norm 2: 11446

DIN AND CIGARETTE LIGHTER

SOCKETS

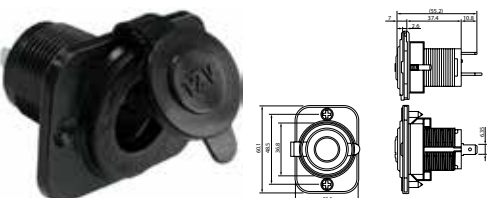
161717 Lighter Socket Std pkg 1 Servicing: HC-CARGO 181679, 181680, 181681

Voltage: 12/24
Amp: 20

ID/mount. hole: 29 mm
Connection: Terminal

Connection: Terminal
Cap: w/
Male/female: Female

TRAILER PLUGS - 12 V

13 PIN

181692 Trailer Plug

Std pkg 1

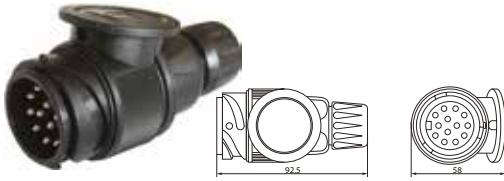

Voltage: 12

Connection: Screw

Socket: 7-13
Colour: Black
No./poles: 13
Connection: Screw

TRAILER SOCKETS - 12 V

13-7 PIN

181675 Trailer Coil

Std pkg 1



Voltage: 12

Cable dim.:
6x1+1x1.5 mm²
Working length: 1.5 m

Plug type: 12N, Colour: Black
Material: Polyurethan
Windings: 15
Plug 1: 7
Plug 2: 13
ISO norm 1: 1724
ISO norm 2: 11446

ISOBUS

181688 Master Socket

Std pkg 1



Voltage: 12

Colour: Black
No./poles: 9

181689 Slave socket

Std pkg 1



Voltage: 12

Colour: Black
No./poles: 9

181690 Plug

Std pkg 1



Voltage: 12

Colour: Black
No./poles: 9
Male/female: Female

181691 Plug

Std pkg 1



Voltage: 12

Colour: Black
No./poles: 4, 9

RELAYS

MULTI PLUGS

193373 Relay Multiplug

Std pkg 10

Servicing: HC-CARGO 160480, 160983

Terminal: HC-CARGO 192377, 190868, 193238, 192574.

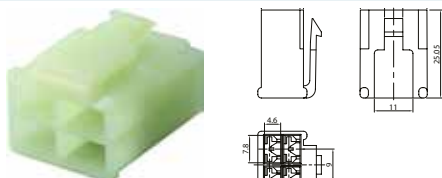

Type: Socket
Colour: White
No./poles: 4
Plug: Female



Application List

Alternators & Starters

Edition 2017/2018





Application list

Case						
AGRICULTURE						
170 6.7		01.10-	115682	14	200	
185 6.7		01.10-	115682	14	200	
200 6.7		01.10-	115682	14	200	
215 6.7		01.10-	115682	14	200	
434						01.69- 116010*
850 G/D/E						01.89- 01.94 116072* 24 5.5
1150 E/G						01.89- 01.94 116072* 24 5.5
170 CVX 6.7		01.10-	115682	14	200	
180 CVX 6.7		01.10-	115682	14	200	
185 CVX 6.7		01.10-	115682	14	200	
200 CVX 6.7		01.10-	115682	14	200	
215 CVX 6.7		01.10-	115682	14	200	
225 CVX 6.7		01.10-	115682	14	200	
230 CVX 6.7		01.10-	115682	14	200	
CS 660 8.3	Cummins					115721 12 4.2
CVX Series			115718	14	140	
Caterpillar						
AGRICULTURE						
Various Models						114718 12 1.4
Claas						
AGRICULTURE						
Various Models 926 936 946	BF6L1013FL	01.05-	115833	14	120	
Deutz-Fahr						
AGRICULTURE						
110	1000.6A		115689	14	80	
130	1000.6A		115689	14	80	
110DT	1000.6A		115689	14	80	
			115850*	14	70	
F100DT	1000.4WT		115689	14	80	
F70DT	1000.3WT		115689	14	80	
F75DT	1000.4W		115689	14	80	
F90DT	1000.4WT		115689	14	80	
Silver			115850*	14	70	
Fendt						
AGRICULTURE						
600 5.7 Diesel	D227-6	02.78-	115987	14	143	
610 5.7 Diesel	D226-6	02.78-	115987	14	143	
611 6.2 Diesel	D226-6	02.76-	115987	14	143	
612 6.2 Diesel	D226-6	02.76-	115987	14	143	
614 6.2 Diesel	TD226-6	02.78-	115987	14	143	
615 6.2 Diesel	TD226-6	02.78-	115987	14	143	
300 SERIES 4.2 Diesel	D226..	02.80-	115987	14	143	
626 LS 11.4 Diesel	D2566ME	02.82-	115987	14	143	
Fermec						
AGRICULTURE						
860, 865, 960, 965, 640B, 650B 3.9 Diesel		01.99-	115848	14	95	
Goldoni						
AGRICULTURE						
Various Models						116013 12 1.8
Huerlimann						
AGRICULTURE						
100DT	1000.4WT		115689	14	80	
55DT	1000.3W		115689	14	80	
70DT	1000.3WT		115689	14	80	
75DT	1000.4W		115689	14	80	
90DT	1000.4WT		115689	14	80	
John Deere						
AGRICULTURE						
2305	Yanmar					116016 12 1.2
2320	Yanmar					116016 12 1.2
1023E	3TNM72					116016 12 1.2
1025R	3TNV76					116016 12 1.2
1026R	3TNV76					116016 12 1.2
2025R	3TNV76					116016 12 1.2
Various Models						115821 24 8.0 114222* 24 7.5 115721 12 4.2
X495	Yanmar 24HP					116016 12 1.2
X595	Yanmar 24HP					116016 12 1.2
X740	Yanmar 24HP					116016 12 1.2
X744	Yanmar 24HP					116016 12 1.2
X748	Yanmar 24HP					116016 12 1.2
X749	Yanmar 24HP					116016 12 1.2
X750	Yanmar 24HP					116016 12 1.2



V A



V kW

X754	Yanmar 24HP				116016	12	1.2
X758	Yanmar 24HP				116016	12	1.2
X950R	Yanmar 24HP				116016	12	1.2
KHD							
AGRICULTURE							
Engine 2.3 TCD2008 TCD 2009							
				115849		28	55
Massey Ferguson							
AGRICULTURE							
5425				115777		14	80
5435				115777		14	80
5445 4.4	1104D-E44TA	01.08-		115777		14	80
5450 4.4		01.11-		115777		14	80
5460 4.4		01.11-		115777		14	80
New Holland							
AGRICULTURE							
Various Models							
					116010*		
Renault							
AGRICULTURE							
Various Models 926, 936							
	BF6L1013FL	01.02- 01.03		115833		14	120
Same							
AGRICULTURE							
100DT	1000.4WT			115689		14	80
70DT	1000.3W			115689		14	80
75DT	1000.4W			115689		14	80
90DT	1000.4WT			115689		14	80
Various Models							
				116077*			
Terex							
AGRICULTURE							
TX750, TX860B, TX860SB, TS960, TS965 4.4 Diesel							
		01.99-		115848		14	95
Various Agriculture Vehicles							
AGRICULTURE							
				116063		28	140
					115355	24	5.4
					115447*	24	8.0
Yanmar							
AGRICULTURE							
Cub Cadet SC2400 0.9							
	Yanmar				116016	12	1.2



V A



V kW



Application List

A/C Compressors

Edition 2017/2018

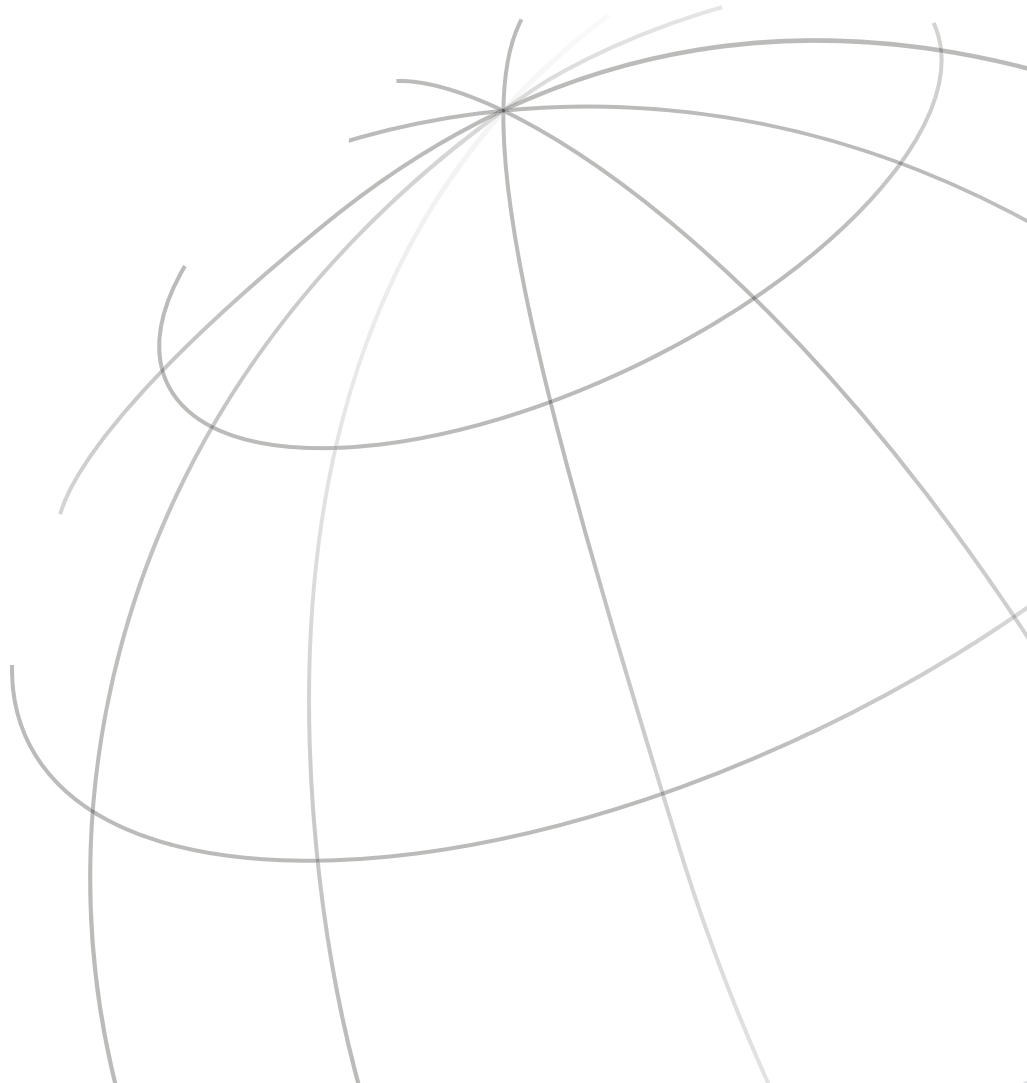



Application list

AGCO			
AGRICULTURE			
1054		241589	
1254		241589	
1844		241589	
6103		241589	
8103,8104,8144		241589	
9103,9105		241589	
Caterpillar			
AGRICULTURE			
Various Models		241583	
Claas			
AGRICULTURE			
980	01.15-	241588	
JCB			
AGRICULTURE			
Various Models		241579	12
		241584	
John Deere			
AGRICULTURE			
Various Models		241166	24
Liebherr			
AGRICULTURE			
Various Models		241580	24
New Holland			
AGRICULTURE			
Various Models		241582	



Cross Reference List

OE No. - HC-CARGO No.

Edition 2017/2018



OE No.	HC-CARGO	OE No.	HC-CARGO	OE No.	HC-CARGO	OE No.	HC-CARGO
AD KÜHNER		CST10783	116044	28-2692	115689	2PG003057-067	171174
254329	115968	CST41106	115968	28-3801	115987	8EL737364-001	116063
254735	115572	CASE		28-6771	115718	8EL737704-001	115987
255143	115991	3136900	172088	48-2756	116063		
301236RI	116063	31636910	172088	48-6586	115780	ISKRA	
553161RI	115605	87359905	115718	51-0638	241166	11.131.145	115721
554010RI	115605			FARCOM		11.131.382	115721
554206RI	115777	CATERPILLAR		106505	115991	11.131.688	115355
AEP		2267683	115794	106906	115817	11.131.870	115355
SND0490	115817	226-7683	115794	107082	114718	11.201.463	115689
SND0766	116016	CAV		111137	115987	11.201.519	116063
851754N	241166	1277670	116063	111236	115987	11.201.757	116063
ALFATRONIX		CLAAS		111641	115724	11.201.881	115848
DD1224400	161072	6005028826	115848	111641	115724	11.201.895	116063
DD1224600	161073	CUMMINS		112988	115718	11.201.895	116063
PV18I	161079	3675225RX	115812	112988	115718	11.203.139	116063
PV18S	161080	3972730	115680	113036	116063	11.203.240	116063
PV24I	161081	4900574	115968	113140	115833	11.203.241	116063
AS-PL		4988274	115680	113280	115794	11.203.298	115689
A0021	116063	DAF		118650	116063	11.203.564	115777
A0349	115718	1340893	115987	119786	115987	11.203.826	115682
BOSCH		DELCO		119879	116063	11.204.175	115682
0001330012	116044	DRA0687	115794	FENDT		11.204.412	115849
0120689530	116063	DRA0732	115833	G515900010100	115987	11.204.413	115605
0120689535	116063	DRA0970	115689	FIAT		AZF4553	115721
0120689571	116063	DRA8290	116063	84141456	115682	AZF4598	115721
0120689574	116063	DRB0005	115845	FRIESEN		AZF4671	115355
0120689587	116063	DRB0005N	115845	9041060	115987	AZF4697	115355
0123510060	115987	DRB0005X	115845	99-38.290	116063	IA0881	115848
0123510074	115987	DRB1060	115987	GUARD-UK		IA1104	116063
0123510075	115987	DRB1640	116063	205	171981	IA1152	115689
0124525119	115718	DRB3130	115987	244	171993	IA1301	115682
0124615053	115987	DRB3130N	115987	317	171984	IA1321	115777
0124655013	115845	DRS0237	115968	335	171989	IA1480	115849
0306003001	172146	DEN		581	170648	IS1056	115721
0306003003	172147	DCP99511	241166	HEAT-ON		IS1241	115355
0306003006	172148	DENSO		1045	060257	AAK3166	115689
0986038290	116063	03101-3180	115968	1050	060258	AAK3563	115689
0986041060	115987	101211-3560	115724	1075	060259	AAK4835	115605
0986041060	115987	101211-3561	115724	120.30.300	060253	AAK4931	115777
0986041640	116063	101211-8390	115792	120.30.310	060252	AAK5166	115848
0986043130	115987	101211-8390	115792	120.30.320	060255	AAK5832	115849
0986043130	115987	101211-8400	115794	120.32.002	060249	AAN5334	115682
CARGO		101211-8401	115794	120.32.102	060250		
070076	070214	101211-8401	115794	120.32.113	060251	JAHN	
170481	171982	428000-0870	116016	1331-2424	060242	1211	171985
170573	171974	428000-2190	115972	1350-3	060263	1221	171975
170574	171976	428000-2190	115972	1350AL	181676	1231	171974
170577	171991	428000-2191	115972	1450-12	060243	1232	171976
170578	171978	428000-2192	115972	1450-24	060244	1248	171991
170658	171979	428000-3130	115817	1518-1	060256	1249	171978
170660	171980	428000-3570	114718	1518-2A	060269	1310	171983
170814	171985	447100-9794	241166	1541-12	060264	1311	171988
170815	171975	447200-4933	241166	1541-24	060265	1312	171996
171472	171983	DOGA		1570AL	181673	1318LL	171979
171475	171984	13650070706	160727	1650-12	060266	1320	171984
171480	171993	DRI		1650-24	060267	1362	171986
171481	171981	200.136.1432	115987	2000-12	060245	1375	171989
171531	171977	225.123.1432	115987	2000-24	060246	1380	171995
171815	172087	225.126.1432	115987	3031-12	060247	1383	170648
20.017-171	171174	525.102.1402	116063	340.06.021	060248	1385	171994
CASCO		DURITE-UK		340.06.023	181674	1390	171998
CAL10265	115987	0-737-33	161059	5061-12	060271	1400	171981
CAL10612	116063	0-890-30	160028	5061-1248	060248	1408LL	171980
CAL10666	116063	0-890-35	160025	5061-12L	060270	1410	171993
CAL21146	115689	ELSTOCK		62338	060260	1415	171990
CAL21152	115682	26-3308	115572	62348	060261	1417	171997
CAL21153	115682			66221	060262	1418LL	171992
CAL40181	115724			HELLA		1855	171987
CAL40390	115792			2PG003057-011	171174	242WO	172170
CAL40621	115794			2PG003057-061	171174	249CB-WO	172182
						252WO	172172
						252YO	172173
						260WO	172159
						260YO	172157
						264RO	172161
						264WO	172160
						264YO	172162
						265RO	172167
						265WO	172168

OE No.	HC-CARGO	OE No.	HC-CARGO	OE No.	HC-CARGO	OE No.	HC-CARGO
271BO	172180	LRA01919	115987	12422	171989	WAI	
271RO	172179	LRA02138	115987	12445	171988	12770N	115794
271WO	172181	LRA02481	116063	12496	170648	18533N	115817
342WO	172171	LRA03476	115780	12498LL	171979	8722N	115680
352RO	172174	LRA03631	115718	12503	171994		
352WO	172175	LRS00555	115572	12718	171985	WOOD-UK	
352YO	172176			12728	171975	ALT30465	115792
360WO	172163	MARELLI		12748	171974	ALT30515	115794
364RO	172165	944390410600	115987	12814LL	171992	BLB144	171993
364WO	172164			12821LL	171980	BLB145H	171987
364YO	172166	MASSEY FERGUSON		13241	171978	BLB205	171981
365WO	172169	4287013M1	115777	13324	171986	BLB234	171991
371RO	172177	6106495M91	115848	13413	171997	BLB244	171993
371WO	172178			13445	171996	BLB317	171984
7234	171977	MENBERS		13748	171976	BLB335	171989
JCB		005604 00 7/13	181677	6402	171998	BLB335	171989
714-36100	115780	181677	181677	6421	171995	BLB393	171977
JOHN DEERE		MERCEDES BENZ		6445/99	171983	BLB394	171985
AH165975	115605	0081547802	116063	6498	171984	BLB395	171975
AM134946	115817	0101541502	115987	6814	171993	BLB395H	171975
AT117390	115605	0101541602	115987	6821	171981	BLB396	171974
AT168543	241166	0111545002	116063	PSH		BLB398	171976
AT172975	241166	0131547302	116063	425.504.045	115724	BLB581	170648
AT300167	115845	A0101541502	115987	525.501.120	115833		
AT387574	115845	A0101541602	115987	645.011.095	115680	YANMAR	
M810337	116016			645.021.130	115812	119626-77020	116016
RE504009	115721	MITSUBISHI		646.023.095	115794	165000-47590	115991
RE523502	115721	M000T84281	115991	650.502.103	115721		
RE533654	115605	MOT84281	115991	700.520.102	115991		
RE68783	115721			980.530.092	116016		
SE501343	115605	NEW HOLLAND		PUROLATOR			
SE501838	115845	73327987	115689	40222	070214		
SE502628	115605	87565015	115682	RADEX			
SE502632	115721			2800-10	172153		
KAWASAKI		NIKKO		2800-13	172154		
21163-7020	115817	0-35000-3370	115780	2900-10	172155		
21163-7028	115817	NRF		2900-13	172156		
KHD		32662G	241166	REMY (DELCO)			
01183033	115355	OSRAM		10459456	115812		
01183461	115849	5001	171993	19020204	115680		
01183463	115849	5006	171981	19020375	115812		
04114396	115849	5007L	171980	RENAULT			
04115327	115849	5008L	171992	7700053184	115833		
04118044	115849	5631	171990	SAME			
04119001	115849	7234	171977	294397320	115689		
1183033	115355	7240	171994	SAW			
1183461	115849	7326	171985	20.017-171	171174		
1183463	115849	7327	171975	SPIDAN			
LESTER		7351	171974	5685	116063		
12264	115780	7360	171976	5791	115987		
12468	115792	7501	171984	UNIPOINT			
12770	115794	7506L	171979	ALT-T145	116063		
12816	115848	7507	170648	VALEO			
17643	115572	7526	171983	2542475	115833		
18533	115817	7527	171988	434016	116063		
19188	115968	7535	171996	434027	116063		
19897	115972	7569	171991	437326	115833		
8722	115680	7597	171986	437701	115987		
LISTER		7669	171978	439322	115833		
204-13273	115572	7869	171991	A13VI284	115833		
LUCAS		PACCAR		AC730732	115833		
26270	115572	D276001013	115792	VM			
27410	115572	PERKINS		3.852.2287F	115724		
ELBX395	171975	185086570	115991	VOLVO			
LES0032	115572	185086680	114718	10219978	116044		
LLB394	171985	2871A703	115794				
LLB395	171975	287A703	115794				
LLB581	170648	PHILIPS					
LLB581PX2	170648	12241	171991				
LLB581T	170648	12413	171990				



Index

Edition 2017/2018



HC-CARGO	Page	HC-CARGO	Page	HC-CARGO	Page	HC-CARGO	Page
060257	45	160025	54	171982	39	172135	37
060258	45	160028	54	171983	39	172136	37
060259	45	160035	54	171984	39	172137	32
060260	45	160727	54	171985	39	172139	32
060261	45	161042	54	171986	39	172140	32
060262	45	161051	46	171987	40	172142	32
060263	45	161052	47	171988	39	172143	37
060264	44	161053	47	171989	39	172144	28
060265	44	161054	47	171990	39	172145	34
060266	44	161055	47	171991	39	172146	27
060267	44	161058	47	171992	39	172147	27
060268	46	161059	49	171993	39	172148	27
060269	46	161072	49	171994	39	172149	29
060270	44	161073	49	171995	39	172150	29
060271	44	161078	50	171996	39	172151	30
070214	54	161079	49	171997	39	172152	30
114222*	14	161080	49	171998	39	172153	28
114718	12	161081	49	172087	30	172154	29
115355	15	161083	50	172088	34	172155	29
115447*	15	161084	50	172089	31	172156	29
115572	15	161085	50	172090	31	172157	40
115605	10	161087	50	172091	31	172159	40
115680	6	161088	50	172092	27	172160	40
115682	6	161089	50	172093	27	172161	40
115689	7, 8, 10	161091	51	172094	33	172162	40
115718	6	161092	51	172095	38	172163	40
115721	12, 14	161093	51	172096	38	172164	40
115724	6	161095	51	172097	38	172165	40
115738	7	161096	51	172098	38	172166	40
115777	9	161097	51	172099	33	172167	40
115780	8	161099	51	172100	33	172168	40
115802	15	161100	52	172101	34	172169	40
115812	8	161101	52	172102	27	172170	40
115814	10	161103	52	172103	26	172171	40
115817	14	161104	52	172104	26	172172	40
115821	14	161105	52	172105	35	172173	40
115831*	6	161107	52	172106	35	172174	40
115833	7, 9	161108	52	172107	35	172175	40
115845	9	161109	53	172110	33	172176	40
115848	8, 10	161111	53	172111	39	172177	40
115849	9	161112	53	172112	31	172178	40
115850*	7	161113	53	172113	31	172179	40
115954	16	161115	53	172114	34	172180	40
115968	16	161116	53	172115	33	172181	40
115970*	10	161122	48	172116	38	172182	40
115971*	9	161712	48	172117	30	172183	34
115972	12	161713	53	172118	31	172184	34
115987	7	161714	48	172119	35	172186	26
115991	16	161715	48	172120	35	172187	26
115995*	6	161716	48	172121	31	172189	26
116005*	12, 12, 13	161717	56	172122	32	172190	26
116010*	6, 9	161718	48	172124	32	172191	37
116013	13	170648	39	172125	32	172192	28
116016	14, 16	171174	30	172126	35	172193	28
116025*	16	171974	39	172127	36	172194	28
116044	16	171975	39	172128	36	181673	46
116063	10	171976	39	172129	36	181674	46
116070*	15	171977	39	172130	36	181675	57
116071*	12	171978	39	172131	36	181676	46
116072*	12	171979	39	172132	36	181677	56
116077*	15	171980	39	172133	37	181687	54
116086	13	171981	39	172134	37	181688	57

HC-CARGO	Page	HC-CARGO	Page	HC-CARGO	Page	HC-CARGO	Page
181689	57						
181690	57						
181691	57						
181692	57						
193369	56						
193370	56						
193371	56						
193372	56						
193373	57						
241166	18						
241293*	19						
241577*	19						
241578*	19						
241579*	18						
241580*	19						
241582*	19						
241583*	18						
241584*	18						
241588*	18						
241589*	18						
250305	23						
250306	24						
250307	24						
250345	22						
253483	24						
253484	24						
253485	24						
253486	22						
253487	22						
253490	24						
253491	24						
253492	24						
253517	22						
253520	22						
253521	23						
253522	23						
253523	23						
253524	23						
253577	22						
253581*	23						
253583	23						

